



MIRION
TECHNOLOGIES

Edition 4.0



Spectroscopy and Scientific Analysis Systems

Laboratory, Field and
Personnel Applications





MIRION
TECHNOLOGIES

Protect What's Next.™

Advancing Radiation Safety.

At Mirion Technologies, we partner with industry leaders to advance radiation safety and empower the next wave of critical innovation. From detection and measurement to monitoring and analysis, we empower innovators across industries with radiation safety technologies that operate with the highest levels of precision. We partner with our customers to build solutions that deliver complete confidence in safe operations and harness the transformative power of safe radiation to move our world forward.



MIRION
TECHNOLOGIES

Spectroscopy and Scientific Analysis Systems

Advancing Knowledge. Empowering Breakthroughs.

Our spectroscopy instruments and software help advance knowledge and understanding of radioactive materials, empowering the next wave of breakthrough science and innovation.

LABORATORY, FIELD AND PERSONNEL APPLICATIONS

Mirion has products and expertise, around the world, in the following areas:

- Integrated gamma and alpha spectroscopy hardware and software
- Specialty Germanium and Silicon detectors for research and industrial applications
- Applied systems for whole body counting and in situ measurements
- Low background alpha/beta counting systems
- Data management systems
- Environmental monitors
- Training and technical assistance for all of the above

LEARN MORE: [MIRION.COM](https://www.mirion.com)



Our customers around the world operate in facilities with exacting standards for safety, reliability and defensibility of results.

TABLE OF CONTENTS

1. Radiological Counting Labs	6	Osprey-Compatible Scintillation Detectors.....	18
Gross Alpha/Beta Counting		GR1™ Compact CZT Spectrometer	19
Series 6LB™ Automatic Low Background Alpha/Beta Counting System	8	GR1-SHIELD™ Shield and Collimators	19
Series 5 LB5500™ Automatic Low Background Alpha/Beta Counting System	8	Genie™ Spectroscopy Software Suite.....	20
Apex-Alpha/Beta™ Counting Productivity Software	8	Apex-Gamma™ Lab Productivity Suite	21
LB4200™ Multi-Detector Low Background Alpha/Beta Counting System	9	Apex-Guard™ Option	21
iSolo® Portable Gasless Alpha/Beta Counting System	9	ISOCS™/LabSOCS™ Mathematical Efficiency Calibration Software.....	21
iMatic™ Gasless Automatic Alpha/Beta Counting System	9		
Gamma Spectroscopy		Alpha Spectroscopy	
High Purity Germanium (HPGe) Detectors.....	10	Alpha Analyst™ Integrated Alpha Spectrometer.....	22
iPA™ Intelligent Preamplifier	11	PIPS® Passivated Implanted Planar Silicon Detectors.....	22
Standard Electrode Coaxial (SEGe).....	11	Apex-Alpha™ Alpha Spectroscopy Software Suite.....	23
Reverse Electrode Coaxial (REGe)	11		
Broad Energy (BEGe)	11	2. In Vivo Measurement	24
Extended Range Coaxial (XtRa).....	11	FASTSCAN™ High Throughput Whole Body Counter	26
Small Anode (SAGe) Well	12	ACCUSCAN II™ Scanning Germanium Whole Body Counter	26
Low Energy (LEGe)	12	ACCUSCAN™ Horizontal Bed Whole Body Counter	26
Ultra-LEGe (GUL)	12	2270 Actinide Lung Counter	27
Cryo-Pulse® 5 Plus Compact Electric Cryostat	13	2275 Actinide Lung and Scanning Whole Body Counter	27
Intelligent Cryo-Cycle™ Hybrid Cryostat.....	13	Apex-InVivo™ Whole Body and Lung Counting Productivity Software.....	27
747 Top Opening Lead Shield	14		
767 Top and Front Opening Lead Shield.....	14	3. Research and Education	28
777 Ultra Low-Background Shield.....	15	Gamma Spectroscopy Products	
737 U-Style Lead Shield	15	LABKIT Nuclear Science Experiments for Teaching Laboratories.....	30
CosmicGuard™ Cosmic Veto Background Reduction System	15	S600C ProSpect® Gamma Spectroscopy Software	30
Lab-Pulse™ Services.....	16	HPGe Detector Configurations for Nuclear Physics Research	
Lynx® II Digital Signal Analyzer.....	17	Clover™ Detectors Array of Four HPGe Detectors	31
DSA-LX® Digital Signal Analyzer	17	High efficiency HPGe Array Solutions	31
Osprey® Digital MCA Tube Base for Scintillation Spectrometry.....	18	Segmented Coaxial Ge Detectors for Position Information.....	32
		Inverted & Segment Coaxial Type Ge Detector.....	33



Specialty Ultra Low Background (S-ULB) Detectors

S-ULB Specialty Ultra-Low Background Cryostats 35
 SAGE™ Small Anode Germanium Detectors 35

Silicon Detector Configurations for Nuclear Physics Research

PD, RF and A-Series PIPS® Detectors for Charged Particle Detection..... 36
 FD-Series PIPS Detectors for ΔE-Detection..... 36
 Silicon Photodiodes for Beam Monitoring 36

X-Ray Detectors for Synchrotron Applications

Monolithic HPGe Pixel Detectors 37
 Discrete Single and Array Detectors HPGe..... 37
 DSSD HPGe Double-Sided Strip Detectors 37
 X-PIPS™ Series Detectors for Photon Detection (From Near UV to 30keV) 37

Custom Detectors for Space and OEM Applications

Ruggedized HPGe Detectors for Space Exploration..... 38
 Encapsulated Ge Detectors 38
 PIPS Detectors for Space Exploration 39
 OEM Solutions for XRF-XRD-EDX Benchtop and Handheld 39

4. In Situ Measurement.....40

Aegis™ Transportable HPGe Spectrometer 42
 MicroGe™ Compact HPGe detector 42
 S573C ISOCS™ Calibration Software..... 43
 ISOXSHLD ISOCS™ Shield Systems 43
 Data Analyst™ Continuous Monitoring Solution 44
 SPIR-Ace™ RIID with the GenieXPort™ Application 44
 FoodScreen™ Radiological Food Screening System..... 45
 Genie-FieldPro™ Gamma Spectroscopy Sample Counting Software 45

5. Waste Management and Special Systems46

Series Q2™ Qualitative and Quantitative Gamma Waste Assay System..... 48
 Auto Q2 Low Level Waste Assay System 48
 WM2200 Series Segmented Gamma Scanner 49
 TGS™ Tomographic Gamma Scanner 49
 WM2500 Modular Gamma Box and Container Counter™ 50
 HKED Hybrid K-Edge/XRF Analyzer 50
 NDA 2000™ Non-Destructive Assay Software 51

6. Customer Support Services52

Mirion Nuclear Services

Installation Services 54
 Real-Time State of Health Monitoring 54
 Professional Training Services..... 54
 Routine System Management and Maintenance 55
 Calibration Services..... 55
 Procedure Writing 55
 Programming..... 56
 Data Review 56
 Site Specific Customizations..... 56
 Routine Operations 56
 Performance Testing Programs 57
 System Audits 58

Radiological Counting Labs

In the laboratory count room, Mirion's time-tested software packages, teamed with a full complement of innovative detectors and signal processing electronics, offer customers sophistication with simplicity.



Alpha Analyst™ Integrated Alpha Spectrometer



High Purity Germanium Detectors



Detector, Intelligent Cryo-Cycle™ Hybrid Cryostat and 747 Lead Shield

LabSOCS™ Calibration Software

The Apex® family of lab productivity software is designed to handle the work load of a busy lab.

APEX SOFTWARE

Apex software serves as the user and management interface for counting systems. It automatically ensures that routine QA checks are performed and automatically keeps records of all system activities – sample counts, calibrations, QA checks – as well as when they were performed and by whom. Unique database facilities make it simple to retrieve and review data – even years after the measurement – to respond to questions or legal challenges.

ISOCS™ AND LABSOCS™ CALIBRATION SOFTWARE

ISOCS™ and LabSOCS™ Calibration Software bring a new level of capabilities to gamma sample analysis by eliminating the need for traditional calibration sources during the efficiency calibration process. In addition to the monetary savings from not having to purchase, track or dispose of numerous calibration sources, the ISOCS and LabSOCS calibrations also save time in the field and laboratory, respectively.

PREDICTIVE MAINTENANCE

Lab-Pulse™ Services can maximize the uptime of your instruments, improving operational efficiencies. With predictive maintenance, you can further extend the lifetime of your HPGe detectors. Using connected technologies, Lab-Pulse Services provides 24-7 monitoring of your instruments and can help identify issues before they result in downtime.

Gross Alpha/Beta Counting

Automatic Gas Flow Counting Systems



Series 6LB™ Automatic Low Background Alpha/Beta Counting System

FEATURES

- 50/100 sample automatic changer system
- High performance 5.7 cm (2.25 in.) gas flow detector
- Integrated 7" touch screen display
- Interchangeable 50 and 100 sample Lock and Load stacks
- Complete front access – all critical components slide forward out of the shield
- Gasless guard detector – extends P-10 tank life to more than a year
- Automatic gas monitoring and conservation system
- Integrated self-diagnostics and environmental monitoring for temperature, humidity and barometric pressure
- USB Communication protocol to Apex-Alpha/Beta computer



Series 5 LB5500™ Automatic Low Background Alpha/Beta Counting System

FEATURES

- Automatic sample changer for 50 samples
- 12.7 cm (5 in.) gas flow detector and 50 sample capacity
- Enhanced low background capability
- Gas Stat™ digital gas conservation and monitoring system

Apex-Alpha/Beta™ Counting Productivity Software

FEATURES

- Control and Analysis software for most Canberra™ gas-flow alpha/beta counters
- Compatible with LB4200, LB4100, Mini20, IN20, Series 6LB and Series 5 systems
- Feature by feature replacement for Eclipse
- Express Count for immediate counting with no sample data pre-entry
- Calibration and QC Sequences
- Automated Plateau and Region of Interest setup
- Unattended Calibration on Changer Systems



Manual Gas Flow Counting Systems



LB4200™ Multi-Detector Low Background Alpha/Beta Counting System

FEATURES

- Manual drawer-based system for counting up to 16 samples at the same time
- Optimal for counting multiple samples with long count times that are not practical for single detector counters
- Up to four 5.7 cm (2.25 in.) or 3.1 cm (1.25 in.) detectors or one 12.7 cm (5 in.) detector per counting drawer
- Configurable and upgradeable from one to four counting drawers
- High performance gas flow detectors with ultra-thin windows
- Gas Conservation and Monitoring System for maximum gas cylinder life
- Full front detector access without lifting lead shielding
- Small foot print and modular design
- Independent detector start/stop

Gasless Counting Systems



iSeries™ Gasless Alpha/Beta Counting Systems

FEATURES

- Includes PIPS® silicon gasless detector
- Automatically identifies and compensates for radon, thoron and progeny interference in air filters
- Supports other types of samples without radon / thoron compensation
- NiMH battery power for 6+ hours of continuous operation
- No computer required for operation – simple front panel controls
- Compatible with iLink™ iSeries Communications Software

iSolo® Portable Gasless Alpha/Beta Counting System

FEATURES

- Portable, manual, single-sample alpha/beta counter
- Compatible with sample diameters from 25 to 101 mm
- Various shielding and guard detector options to minimize background

iMatic™ Gasless Automatic Alpha/Beta Counting System

FEATURES

- Automatic sample changer with 50 or 100 sample capacity
- Compatible with sample diameters from 25 to 60 mm
- Molded low background shielding, 10 cm (4 in.) thick

Gamma Spectroscopy

Structure Code:

Active Volume
 Diffused
 Contact (N+) Implanted or Barrier Contact (P+)
 Passive Surface

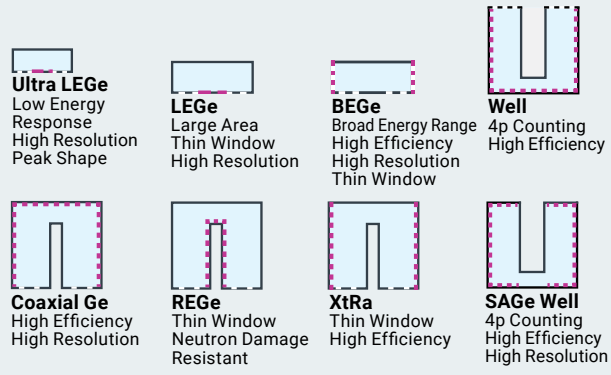

Detector Type:

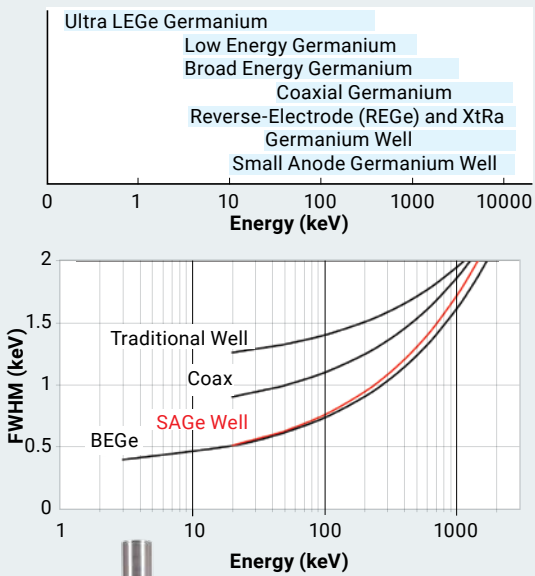

High Purity Germanium (HPGe) Detectors

- Wide variety of HPGe detector types and efficiencies are available:
 - Standard Electrode Coaxial (SEGe) – P-type
 - Reverse Electrode Coaxial (REGe) – N-type
 - Extended Range Coaxial (XtRa)
 - Broad Energy (BEGe)
 - Low Energy (LEGe)
 - Ultra-Low Energy (GUL)
 - Small Anode Well (SAGe Well)
 - Ge Well (Well)
- HPGe is the best available detector technology for analysis of complex gamma spectra
 - Below are spectra from three common types of gamma detectors: NaI(Tl), Cadmium zinc telluride (CZT) and HPGe
 - HPGe offers superior peak resolution performance compared to all other detector technologies
 - Broader peaks are harder to segregate from each other

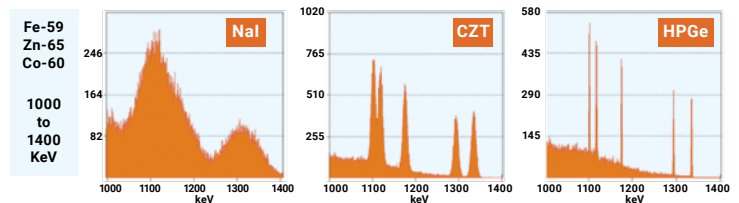

- Conventional liquid nitrogen (LN₂) cryostats are available for all applications
 - **Laboratory** – Vertical or Horizontal w/30-liter or smaller Dewars
 - **Portable** – All-attitude MAC & Big MAC Cryostats
 - **Electrically-cooled** or hybrid electric/LN₂ cooled cryostats also available
- Ultra Low Background (ULB) for HPGe detectors is possible with special cryostat materials and a Remote Detector Chamber (RDC) to separate the preamplifier from detector crystal
 - Vertical configuration (shown)
 - U-style configuration (see 737 U-Style Lead Shield)



iPA™ Intelligent Preampfier

All HPGe detectors with RC-feedback include the iPA Intelligent Preampfier, which includes a built-in USB port for 24/7 key detector parameter data.

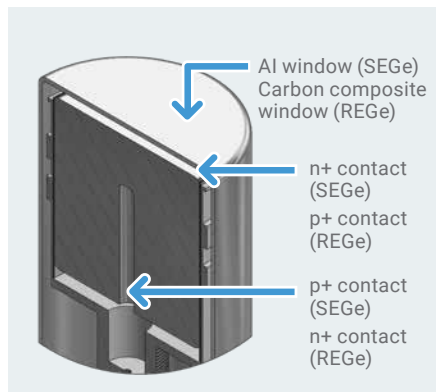

Standard Electrode Coaxial (SEGe)

FEATURES

- Energy range: 40 keV to >10 MeV
- High resolution – good peak shape
- Excellent timing resolution
- High energy rate capability

Reverse Electrode Coaxial (REGe)

FEATURES

- Spectroscopy from 3 keV to >10 MeV
- Ultra-thin ion implanted contacts
- Radiation damage resistant
- Excellent timing resolution
- High energy rate capability

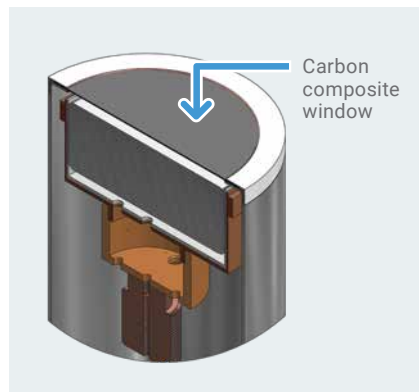

Broad Energy (BEGe)

FEATURES

- Energy range: 3 keV to 3 MeV combining advantages of Low Energy and Coaxial HPGe detectors
- Efficiency and energy resolution optimized for 3 keV to 662 keV region where most tightly-grouped peaks of interest are located
- Flat crystals offer optimum efficiencies for samples counted close to the detector
- Lower Compton continuum at lower energies resulting in much better MDA
- Detector of choice for Actinide Lung Counting

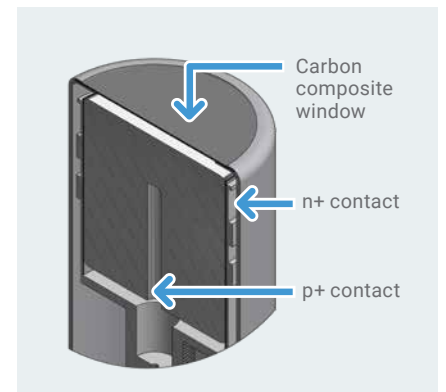

Extended Range Coaxial (XtRa)

FEATURES

- Spectroscopy from 3 keV to >10 MeV
- Wide range of efficiencies
- High resolution – good peak shape
- Excellent timing resolution
- High energy rate capability

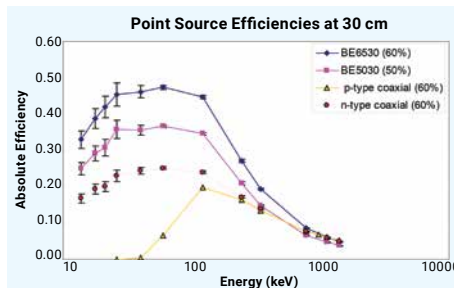

Absolute Efficiency vs. Energy comparison for BE6530, BE5030, GC6020 (p-type coaxial) and GR6022 (n-type coaxial) detectors

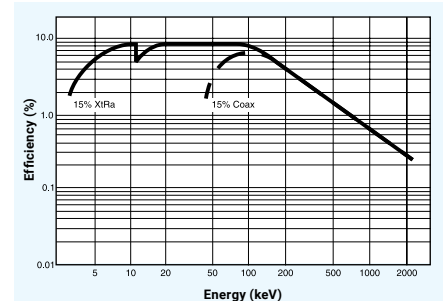

Typical Efficiency curves comparing XtRa with Be window and Coax Detectors with detector-source spacing of 2.5 cm

Gamma Spectroscopy
continued

High Purity Germanium (HPGe) Detectors

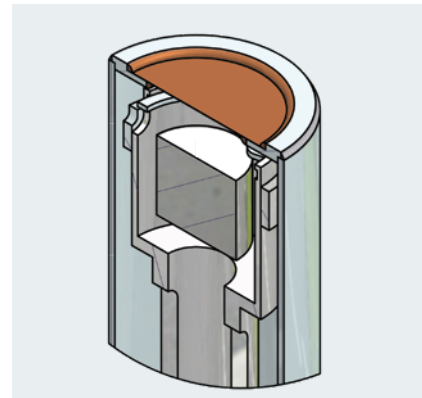
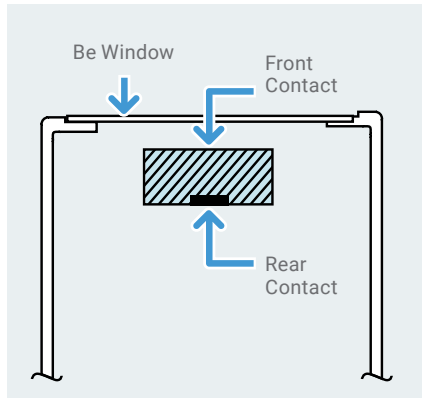
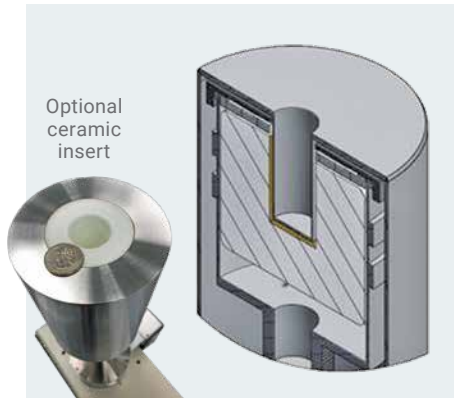

Small Anode (SAGe) Well

FEATURES

- Blind well approaches 4π counting geometry yielding high absolute efficiency
- Superior resolution compared to Traditional Well Detectors at both low and high energies
- Thin stable contact inside well and optional ceramic well insert allows spectroscopy from 10 keV up to 10 MeV
- Large well diameter (28 mm) available with the same excellent resolution as the standard (16 mm) well sizes
- Samples can be counted in the well, on the detector face and in Marinelli beakers
- Compatible with LN_2 and electric coolers (Cryo-Pulse[®] 5 Plus and intelligent Cryo-Cycle)
- Full LabSOCS™ characterization available, allowing True Coincidence Summing correction

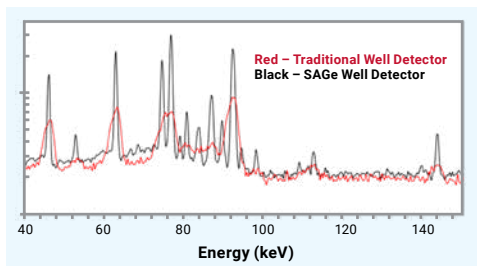

Low Energy (LEGe)

FEATURES

- Thin front and side contact, allowing spectroscopy from 3 keV up
- Wide range of sizes allows selecting the best detector for your application
- Low noise and high resolution at low and moderate energies
- Available standalone or in arrays
- Excellent for X-ray absorption spectroscopy, nuclear safeguards and XRD / XRF applications

Ultra-LEGe (GUL)

FEATURES

- Spectroscopy from 300 eV to 300 keV
- High efficiency compared to Si(Li) and SDD
- Excellent resolution up to very high count rates
- High peak/background ratio
- Available standalone or in arrays
- For XRF, XAS (XAFS, EXAFS, XANES) and X-ray spectroscopy applications

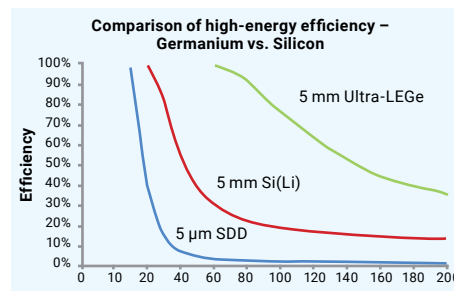
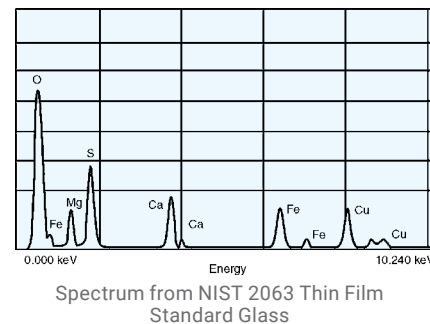

Electrically-Cooled Cryostats

High Purity Germanium Detectors must be maintained at cryogenic temperatures. Traditionally, this has been done by placing the detector assembly in a Dewar filled with liquid nitrogen (LN₂). The LN₂ must be replaced due to boil-off every week to two weeks, which costs money and wastes valuable counting time. The Cryo-Pulse® 5 Plus (CP5-Plus) and intelligent Cryo-Cycle Cryostats eliminate the need to continually refill the Dewar but still keep the detector at LN₂ temperatures.

Cryo-Pulse® 5 Plus Compact Electric Cryostat

FEATURES

- Electrically refrigerated cryostat with no LN₂ requirement
- Sealed system using non-CF4 non-flammable refrigerant
- Low power consumption
- Compact and lightweight – excellent for space-constrained areas
- Long-life cooler with 5-year warranty
- Low maintenance
- No compromise on performance specifications

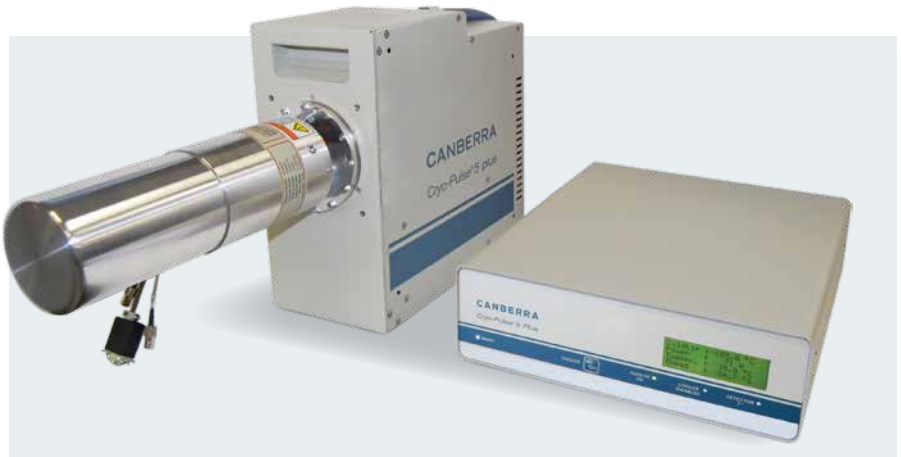

Intelligent Cryo-Cycle™ Hybrid Cryostat

FEATURES

- Low-vibration/low electrical noise even at low energies (no spectral resolution degradation)
- Low audible noise (<50 dB(A) at 1 m)
- LN₂ redundancy
- Non-CFC/non-flammable refrigerant
- Same footprint as standard LN₂ Dewar
- Low power demand (130 W nominal for typical detector configuration)
- Local (via LCD Screen) and remote State-of-Health monitoring
- Four years of onboard system memory for State-of-Health storage
- Lab-Pulse™ ready
- No maintenance required



Blue LCD backlight: Unit operates normally, no action is required.



Yellow LCD backlight: Unit operates but requires attention, see error message for details.



Red LCD backlight: Unit does not operate properly, see error message for details.

Gamma Spectroscopy
continued

Lead Shield



747 Top Opening Lead Shield

FEATURES

- Four inch thick low-background lead shield
- Graded tin and copper liner
- Easy to use lever-actuated door
- Compact – 60 x 60 cm (2 x 2 ft) floor space
- Supports conventional 30-liter Dewar or intelligent Cryo-Cycle Cryostat
- Cryo-Pulse® 5 Plus Cryostat also supported with stand



767 Top and Front Opening Lead Shield

FEATURES

- Four inch thick low-background lead shield
- Graded tin and copper liner
- Full area front door and synchronized split top door
- Compact – 60 x 60 cm (2 x 2 ft) floor space
- Supports conventional 30-liter Dewar or intelligent Cryo-Cycle Cryostat
- Cryo-Pulse 5 Plus Cryostat also supported with stand



Intelligent Cryo-Cycle Cryostat and Model 747 Lead Shield



Cryo-Pulse 5 Plus Cryostat and Model 747 Lead Shield

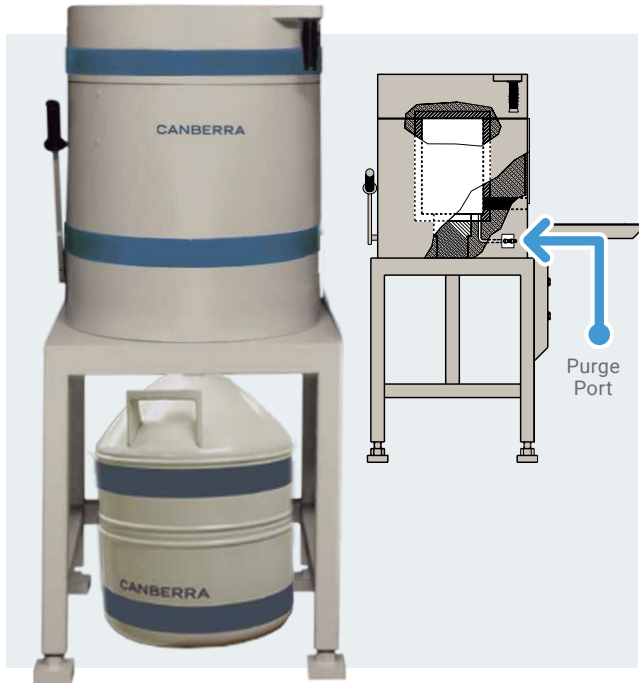

777 Ultra Low-Background Shield

FEATURES

- 15 cm (6 in.) lead thickness
- Ultra low-background materials
- Versions for vertical or U-style cryostats
- Purge port for radon expulsion
- Supports conventional 30-liter Dewar or intelligent Cryo-Cycle Cryostat
- Cryo-Pulse 5 Plus Cryostat also supported vertically with stand

737 U-Style Lead Shield

FEATURES

- “No stream” design for U-style cryostat
- Low center of gravity
- Four-inch low background lead
- Graded tin and copper liner
- Easy detector installation
- Supports conventional 30-liter Dewar, intelligent Cryo-Cycle or Cryo-Pulse 5 Plus Cryostat



CosmicGuard™ Cosmic Veto Background Reduction System

FEATURES

- For Cosmic background reduction that cannot be performed with lead shielding alone
- Typical background reduction by 10 – 35% resulting in lower MDA’s and count times
- Turnkey solution for new or existing HPGe detector/shield configurations
- Compatible with most standard HPGe Lead Shields – split or solid top
- Veto Guard Detector electronics built into detector module – no other signal processing electronics required
- Single cable connection to the acquisition PC or network hub
- Requires Lynx® Digital Signal Analyzer and Genie™ or Apex-Gamma™ software of current firmware/ software versions

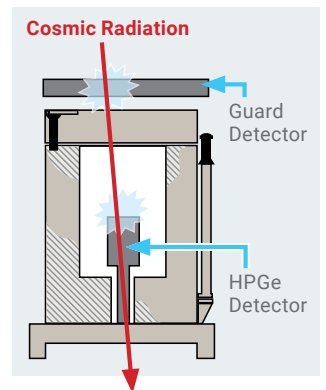

Gamma Spectroscopy continued

Lab-Pulse™ Services

A powerful complement to the Mirion Customer Service Agreement for Gamma Spectroscopy Systems

FEATURES

- Automatic response to instrument hardware alarms by our Technical Support Team
- Access to Instrument Status Dashboard
- Monthly report summaries of instrument uptime and status
- Bi-annual in-depth reviews of instrument State of Health data predictive maintenance recommendations and planning

Lab-Pulse Services is available today for:

- HPGe outfitted with a Mirion Intelligent Preamplifier (upgrades available)
- Mirion Premium Electric Cooler: Cryo-Pulse 5 Plus cryostat
- Mirion New Hybrid Cooler: the Intelligent Cryo-Cycle cryostat

1 Automatic Notifications



Automatic notifications are sent when an alarm is tripped, starting the troubleshooting process faster.

- ✓ Removes need for user to initiate call with Mirion, saving you time.
- ✓ If alarm occurs outside business hours, your team can reorganize counting schedule to minimize impact on productivity.

2 Remote Diagnostics

BY MIRION SERVICE TEAM



Mirion remote Support Technicians can directly review instrument settings, status and errors, and respond rapidly.

- ✓ Reduced need for emergency on-site support visits.
- ✓ Faster response to resolution reduces downtime.

3 Predictive Maintenance



Lab-Pulse Services monitors and reports on instrument State of Health, which are leading indicators of future system issues.

- ✓ Bi-annual in-depth reviews of instrument State of Health data and predictive maintenance recommendations help to proactively prevent downtime.
- ✓ Maximizes lifetime of system and return on investment.

Lynx® II Digital Signal Analyzer

FEATURES

- Fully Integrated Multichannel Analyzer with 32k channel spectral memory, advanced signal processing filters, digital stabilizer, multi-trace oscilloscope and triple-range HVPS for all spectroscopy detector types
- Multiple counting modes: PHA, MCS, PHA & MCS simultaneous, Time-stamped List and Multispectral scaling
- Communication via Ethernet
- Web enabled set-up/operation, compatible with Genie™ software
- Flexible hardware/software controls for sample changers, external acquisition and MCS start/stop, coincidence gating and auto pole/zero
- Software development kit (SDK) available for custom programming



DSA-LX® Digital Signal Analyzer

FEATURES

- Integrated desktop MCA based on Digital Signal Processing (DSP)
- Performs pulse height analysis (PHA) and/or multi-channel scaling (MCS)
- USB 2.0 interface for simple connection to computer
- Web-based digital oscilloscope spectrum viewer and maintenance utility
- Advanced patented auto pole/zero, base line restoration and digital stabilization capability



Gamma Spectroscopy continued



Osprey® Digital MCA Tube Base for Scintillation Spectrometry

FEATURES

- All-in-one high-voltage power supply (HVPS), preamplifier, and digital MCA
- Compatible with all standard 14-pin scintillation detectors, (e.g., NaI(Tl), CeBr₃ and LaBr₃(Ce))
- Optional temperature-stabilized* detectors
- USB 2.0 and Ethernet 10/100T (PoE) connection
- Three programmable general purpose I/O connectors
- PHA, MCS, SCA, MSS, List, and Time-stamped List modes
- Supported by Genie™ software and a software development kit (SDK) with examples
- Diagnostic web GUI
- Compatible with Model 727, 7F7 and TRACS shields

*US Patents 7,005,646 B1 and 7,049,508 B1



Osprey-Compatible Scintillation Detectors

- **802 Detector Family:** NaI(Tl) Scintillation Detectors
- **NAIS-2x2:** NaI(Tl) LED Temperature-Stabilized Scintillation Detector
- **NAIS-3x3:** NaI(Tl) LED Temperature-Stabilized Scintillation Detector
- **NAIS-3x5x16:** NaI(Tl) LED Temperature-Stabilized Scintillation Detector
- **LABR-1.5x1.5:** LaBr₃(Ce) Scintillation Detector
- **CEBRS-1.5x1.5:** CeBr₃ LED Temperature-Stabilized Scintillation Detector
- **CEBRS-2x2:** CeBr₃ LED Temperature-Stabilized Scintillation Detector

FEATURES

- Standard NaI(Tl) Scintillation Detectors of various sizes with and without a well
- Temperature-Stabilized* NaI(Tl) Scintillation Detectors of various sizes including model compatible with the FASTSCAN™ Whole Body Counter
- LaBr₃(Ce) Scintillation Detector
- CeBr₃ Temperature-Stabilized* Scintillation Detectors
- Temperature-stabilized detectors only compatible with the Osprey Digital MCA Tube Base (3x5x16 also with Lynx)
- ISOCS Characterization available or included with most detector models
- Various detector resolution, efficiency and backgrounds available to fit any application and budget

*US Patents 7,005,646 B1 and 7,049,508 B1

Comparison of Scintillation Detector Types

Property	NaI	LaBr ₃	CeBr ₃
Resolution at 662 keV (%)	7%	3 - 3.5%	4.3%
Efficiency	Standard	Above Standard *	Above Standard *
Internal Background	None	Low (La-138, Ac-227)	Very Low** (Ac-227)
Decay time (ns)	250	30	17
Temp. Stabilization Available	Yes	No	Yes
Cost	\$ - \$\$	\$\$\$	\$\$\$ - \$\$\$\$

* Energy dependent - greatest difference from NaI at higher energies

** Mirion offers only detectors meeting a premium low background specification.

GR1™ Compact CZT Spectrometer

FEATURES

- All-in-one detector, electronics and MCA
- Pre-set Gain, 1 cm³ CZT solid state detector
- Miniaturized package: 25 x 25 x 63 mm, 60 g
- USB connection to PC for control and power
- Optional I/O ports for energy and timing outputs and gate inputs
- Interface to Genie™ software for spectral analysis
- Optional Generic ISOCS™ characterization available

GR1 Family Variants	Resolution at 662 keV	USB	Gate Input	Timing Output	Energy Output
GR1	< 2.5%	✓	-	-	-
GR1+	< 2.0%	✓	-	-	-
GR1-A	< 2.5%	✓	✓	✓	✓
GR1-A+	< 2.0%	✓	✓	✓	✓



GR1-SHIELD™ Shield and Collimators

FEATURES

- Two cm thick tungsten shield with handle for any GR1 CZT Spectrometer
- Includes collimators (2mm, 8mm and 35mm) and collimator lock tool
- ISXCZT-GR1 Generic ISOCS Characterization allows the GR1 to provide nuclide activities for in situ measurements
- Optional GR1-ACC Carrying Case with Tripod
- Case holds laptop PC, shield, collimators and tripod



Gamma Spectroscopy continued

NEW GENIE 4.0 AVAILABLE

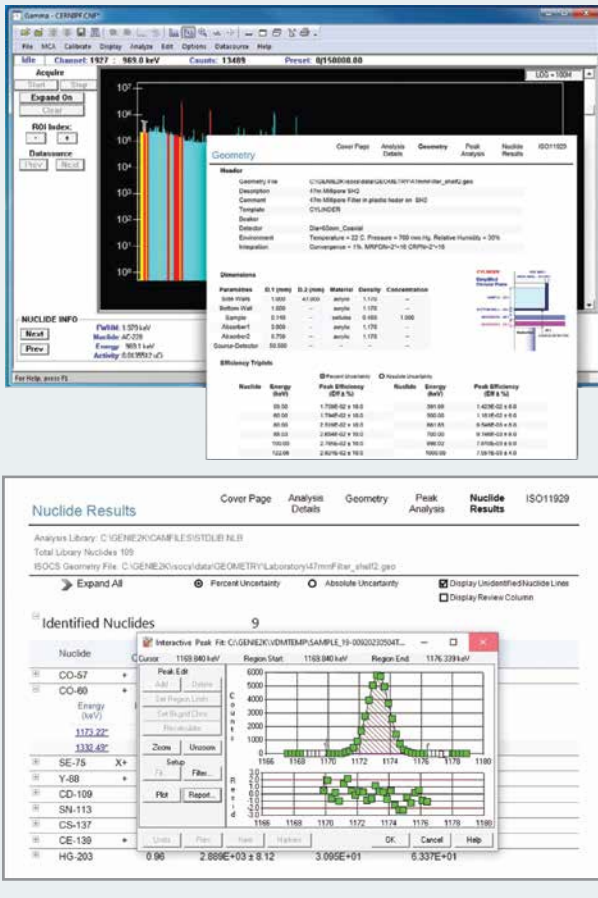

Interactive Peak Fit feature

Genie™ Spectroscopy Software Suite

Genie Spectroscopy Software Suite provides the core software functionality for a comprehensive, high quality, and defensible gamma or alpha spectrometry system.

KEY ENHANCEMENTS IN GENIE 4.0

- ✓ New, time-saving interactive reports for reviewing results
- ✓ Improved uncertainty calculations for correlations in calibration standards
- ✓ New FWHM calibration curve for best fidelity to detector resolution
- ✓ Integrated Python® scripting for flexible automation
- ✓ Expanded support, including N42 files and more

FEATURES

- Integrated data acquisition and analysis
- Independent support for 250+ detector inputs
- Networking for distributed MCA (Multichannel Analyzer) operation and centralized data management
- Wide variety of layered software options for specialized spectroscopy applications
- Qualified with Windows 11, Windows 10, Windows Server 2022, and Windows Server 2019
- Full gamma and alpha spectrum analysis, including:
 - Energy, shape, and efficiency calibrations
 - Background subtraction, reference peak correction, and tracer peak
 - Nuclide identification, interference correction, and weighted mean activity calculations
 - Patented* true coincidence (Cascade) summing correction (requiring no Peak-to-total calibration)
 - 3-Dimensional Geometry Composer for interactive definition and visualization of sample, detector, and absorber parameters
 - Minimum Detectable Activity (MDA) calculations, including ISO 11929 compliance
- Interactive reports for dynamic data review
- Ability to review, adjust, or add/delete peaks in specific Regions of Interest
- Parameter tracking, reporting, and limits evaluation with statistical tests for QA/QC counts
- Integration with Python Scripting for increased automation
- Additional simplified counting interface for screening applications with Genie-FieldPro™ software

*US Patent 6,225,634 B1

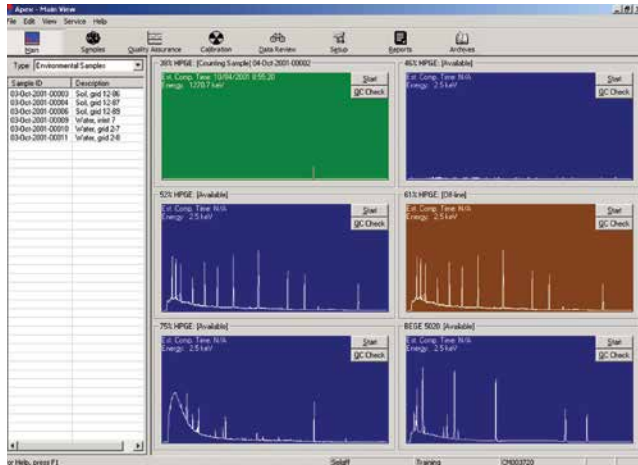

Apex-Gamma™ Lab Productivity Suite

FEATURES

- Comprehensive operation and management software for production-oriented gamma spectroscopy
- Distributed multi-user functionality provides access and control of the system from any client workstation
- Sample database tracks samples from log-in through final data review
- Enforces periodic QA/QC counts and approvals
- Comprehensive security system controls access to system functions
- Seamless integration of gamma spectroscopy results with Canberra NPP effluent management package – OpenEMS™

Apex-Guard™ Option

Augments the Data Integrity of Apex-Gamma:

- Role-based security with Windows Credentials Authentication
- Automatic timed log-off
- Electronic signatures
- Enhanced security for analysis and data processing files
- Dramatically improved auditing capabilities
- Helping FDA-regulated gamma spectrometry achieve laboratory CFR 21 Part 11

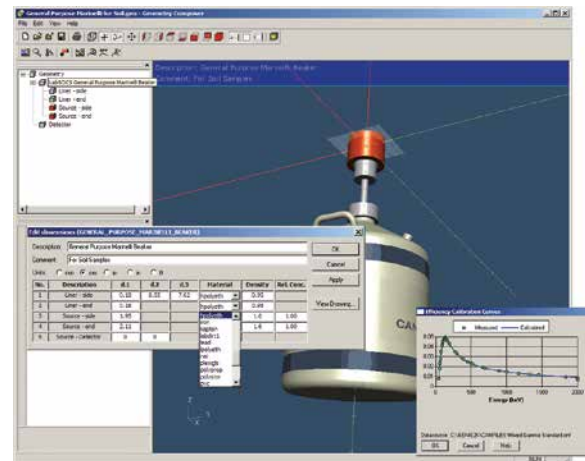

ISOCS™/LabSOCS™ Mathematical Efficiency Calibration Software

FEATURES

- **New!** Now with twice the templates in one comprehensive offering
- Eliminates requirement for expensive radioactive efficiency source standards and their disposal
- Calibrations valid from zero distance to 500 meters (1640 ft) – more than would ever be needed in the count room
- Calibrations valid from 10 keV to 7000 keV and accurate to within a few percent
- Operates with any size or type of germanium detector which has been characterized by Mirion
- Optimized for laboratory applications where complex shaped containers are used repetitively
- Includes model library of commonly available sample containers and tools to easily create custom models for other containers
- Compliant with 2009 U.S. NRC Regulatory Guide 1.21

Alpha Spectroscopy



Alpha Analyst™ Integrated Alpha Spectrometer

FEATURES

- Completely integrated alpha spectroscopy instrument
- 100% computer controlled electronics and vacuum
- Automatic recoil suppression control
- Clean vent port to reduce moisture and contamination buildup in chambers
- Modular for ease of expansion in floor or bench top cabinets
- Connects directly to Ethernet network



PIPS® Passivated Implanted Planar Silicon Detectors

FEATURES

- Contacts are ion-implanted to form precise, thin, abrupt junctions for good alpha resolution
- Entrance window is stable and rugged – it can be cleaned readily and reliably
- Standard detectors are bakeable to 100 °C – higher for special models
- Leakage current is typically 1/8 to 1/100 of that of SSB and DJ detectors
- Low dead layer (window) thickness
- All junction edges are buried – no epoxy edge sealant is needed or used
- A450-18AM is, by far, the most popular model for alpha spectroscopy but other sizes are available

Apex-Alpha™ Alpha Spectroscopy Software Suite

FEATURES

- Comprehensive operation and management software for production-oriented alpha spectroscopy labs
- Supports manual alpha spectrometers and provides complete computer control of Alpha Analyst Spectrometer
- Distributed multi-user functionality for access to system resources from any client workstation
- Includes sample database that tracks batches of samples through log-in, counting and final data review/approval processes
- Intuitive tools for easy creation of sample batches with associated counting and analysis procedures
- Extensive quality assurance capability for scheduling of QA checks, failure identification and response and data trending
- Single screen data review and advanced reanalysis facilities
- Genie™ spectroscopy software core provides well established algorithms for analysis of spectral data

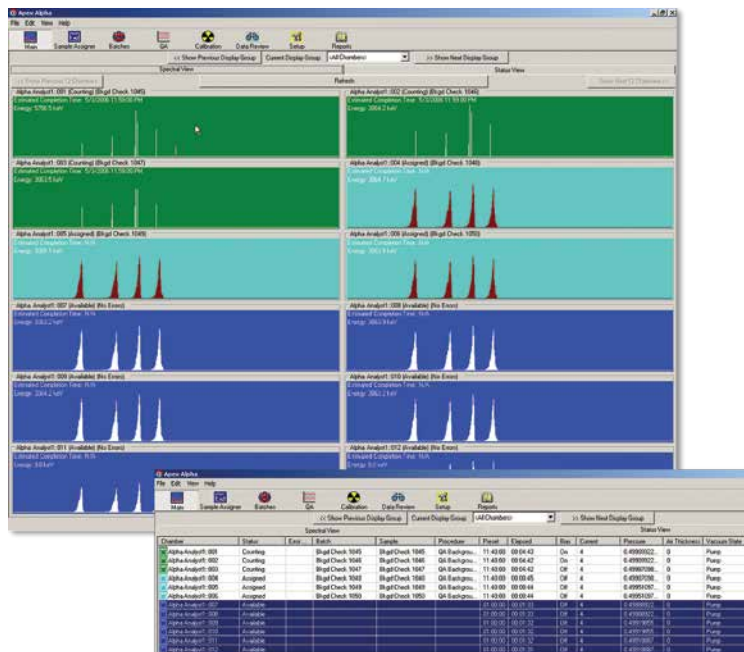

In Vivo Measurement

Mirion has two systems specifically designed to monitor personnel for activation and fission products at nuclear facilities – the FASTSCAN™ and the ACCUSCAN™ whole body counters.

COMMON IN VIVO COUNTER FEATURES

- ✓ Shielded in all straight-line directions by 10 cm (4 in.) of low background steel
- ✓ Modular shield construction for easy assembly
- ✓ Rapid on-site analysis and presentation of results
- ✓ Full spectroscopy systems; not just gross count screening counters
- ✓ Flexibility and ease of operation through Apex-InVivo Whole Body Counting software
- ✓ Standalone Apex-InVivo workstations or networked client/server systems
- ✓ Extensive QA data collection program



Mirion is the leading global supplier for In Vivo Counting systems and has two systems specifically designed for personnel monitoring at nuclear facilities. Both systems employ gamma spectroscopy to provide nuclide identification as well as the activity of any contamination found during a count. This level of detail is not possible with contamination monitors using gas flow or plastic scintillation detectors.

FASTSCAN WHOLE BODY COUNTERS

The FASTSCAN whole body counter is a routine monitoring device which provides very low MDAs and short count times due to its large, moderate resolution/high sensitivity temperature-stabilized NaI(Tl) detectors.

ACCUSCAN WHOLE BODY COUNTERS

The ACCUSCAN whole body counter is available in either a lay-down bed (ACCUSCAN) or a vertical stand-up configuration (ACCUSCAN II™). The ACCUSCAN Bed can accommodate a combination of Sodium Iodide (NaI(Tl)) and High Purity Germanium (HPGe) detectors for high resolution and high sensitivity while the ACCUSCAN II is designed for one or two HPGe detectors. Both ACCUSCAN models are scanning systems that can determine the location of contamination as well as its identity and amount.

Additionally, Actinide Lung Counting Systems are available that are capable of measuring low energy actinides in the lungs with or without the ability to also scan the whole body for fission products.

Like the ACCUSCAN systems, the lung counters use High Purity Germanium (HPGe) detectors to detect and resolve low-energy, low-yield gamma rays from uranium, plutonium, and other actinides located specifically in the lungs. These systems are excellent for use at Uranium and Plutonium handling facilities, nuclear fuel fabrication facilities, and reprocessing facilities.

All of these counting systems employ Apex-InVivo™ Whole Body and Lung Counting Productivity Software for operation, data analysis and reporting. The software's scalable architecture supports standalone counter workstations or the creation of a site-wide network of client/server computers for counter operation and data review.

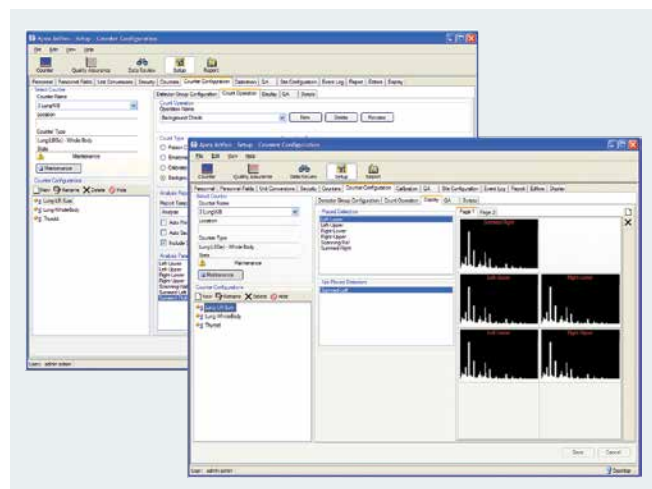

Apex-InVivo™ Software Counter Configuration Screens



FASTSCAN™ High Throughput Whole Body Counter

FEATURES

- Processes 30-50 people per hour
- One minute count time for typical operation
- Two very large, 7.6 x 12.7 x 40.6 cm (3 x 5 x 16 in.), NaI(Tl) detectors
- Temperature-stabilized detectors available to eliminate spectral peak shifts
- 150 Bq (4 nCi) ⁶⁰Co LLD typical for personnel counts
- Vertical linear geometry for accuracy over a wide range of personnel sizes



ACCUSCAN II™ Scanning Germanium Whole Body Counter

FEATURES

- High resolution, standup whole body counter
- Scanning detector mechanism accommodates one or two high purity germanium (HPGe) detectors
- Count times as low as five minutes
- Simultaneous energy and positional spectrum for accurate interpretation of data
- Available with LN₂ or electrically-cooled detectors



ACCUSCAN™ Horizontal Bed Whole Body Counter

FEATURES

- Horizontal, lie-down linear geometry whole body counter
- One 7.6 x 12.7 x 40.6 cm (3 x 5 x 16 in.) NaI detector (standard)
- Count times as low as five minutes
- Computer controlled scanning bed
- Simultaneous energy and positional spectrum for accurate interpretation of data

Available Options:

- One or two HPGe detectors instead of NaI
- Two or three large NaI detectors
- Two HPGe detectors and two NaI detectors
- LN₂ or electrically-cooled HPGe detector



2270 Actinide Lung Counter

FEATURES

- Detector positioner mechanism with six degrees of freedom
- Positioner accommodates BE6530 detectors
- Digital Signal Analyzers for high-resolution signal processing
- Comfortable reclining chair for subject positioning
- Flexibility and ease of operation with Apex-InVivo whole body counting software
- Extensive QA data collection program
- Lung Counting software for automatic chest wall thickness correction
- Turnkey system delivered calibrated and ready to count

System Options and Upgrades for both Counters:

- 15 cm (6 in.) or 10 cm (4 in.) thick low-background steel shield
- The BE6530 with 6500 mm² area and 60% relative efficiency offers excellent minimum detectable activities (MDAs) and shorter counting times
- Cryo-Pulse 5 Plus electrically-refrigerated cryostat for use with BE6530



2275 Actinide Lung and Scanning Whole Body Counter

FEATURES

- Lung detector positioner mechanism with six degrees of freedom
- Lung positioner accommodates BE6530 detectors
- Digital Signal Analyzers for high-resolution signal processing
- Sliding bed for easy subject/patient loading
- 7.6 x 12.7 x 40.6 cm (3 x 5 x 16 in.) scanning sodium iodide detector for whole body counting

- Flexibility and ease of operation with Apex-InVivo whole body counting software
- Extensive QA data collection program
- Lung counting option for automatic chest wall thickness correction
- Detector Anti-Compton Shields to reduce subject-generated background
- Turnkey system delivered calibrated and ready to count

Apex-InVivo™ Whole Body and Lung Counting Productivity Software

FEATURES

- Comprehensive operation and management features for in vivo counting systems
- Distributed multi-user functionality provides access to counters from any client workstation
- Flexible calibration facilities including a verification report and calibrations that are automatically shared across different configurations
- Quality assurance facilities with enforced scheduling policies, and failure response option

- Advanced database features help manage all personnel count data, multiple analyses, and advanced search capabilities in key activities
- Live summed detector groups as well as multi-channel scaling (MCS) groups with defined energy ranges



Research and Education

Mirion detectors and instrumentation have been used in materials analysis, physics, and space studies in the world's leading industries and research institutes.

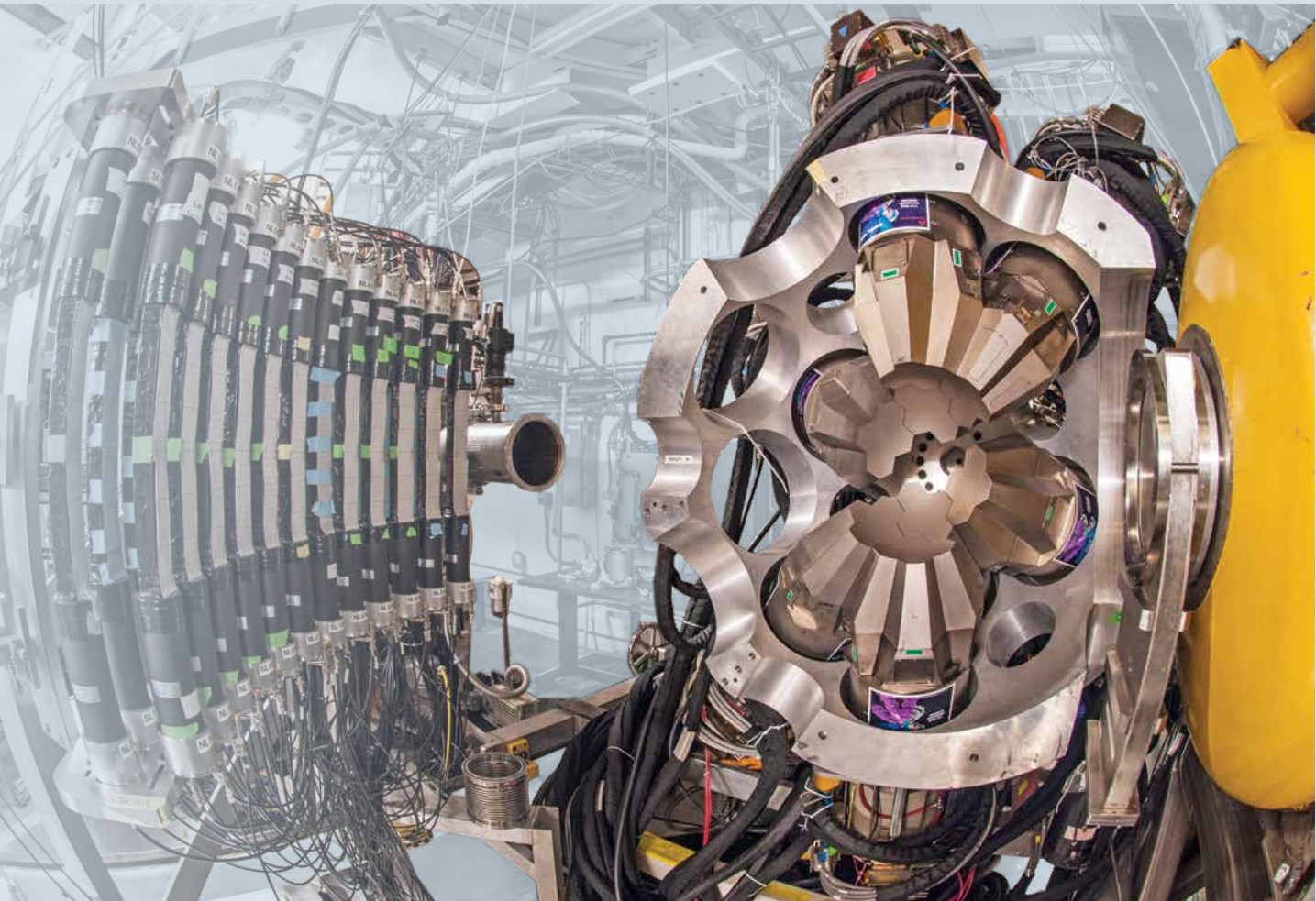

Courtesy of the GRETA collaboration (taken by S. Noji)

A dedicated R&D structure allows us to deliver innovative nuclear detection systems based on a comprehensive exploration of all available and emerging technologies.

EDUCATIONAL RESOURCES

A detailed Nuclear Science Experiments with Digital Electronics Lab Manual and associated Lab Kits are also available to assist with hands on exposure to fundamental and advanced topics of gamma-ray measurement and gamma spectroscopy in teaching and research laboratories.

CRITICAL ALPHA SPECTROSCOPY & ALPHA/BETA COUNTING SOLUTIONS

Detectors such as the Passivated Implanted Planar Silicon variety are used in core products for alpha spectroscopy and alpha/beta counting. They also play critical roles in systems for XRF materials characterization, the space program and physics research.

PROVEN HPGe DETECTORS

High Purity Germanium (HPGe) detectors offer the unique blend of cutting edge technology and proven reliability. From standard coaxial detectors to sophisticated array detectors for scientific research and industrial applications – you can count on consistent quality, high technology and reliability. Electrically-cooled, LN2-free cryostats are available in most configurations.

Mirion Digital Signal Processing products and spectroscopy software are at the heart of our gamma spectroscopy systems. These versatile technologies offer solutions that serve the most demanding requirements of the world's leading researchers and educators. They are not only the components with which the systems are built – but also the tools that are building the future of the nuclear industry.

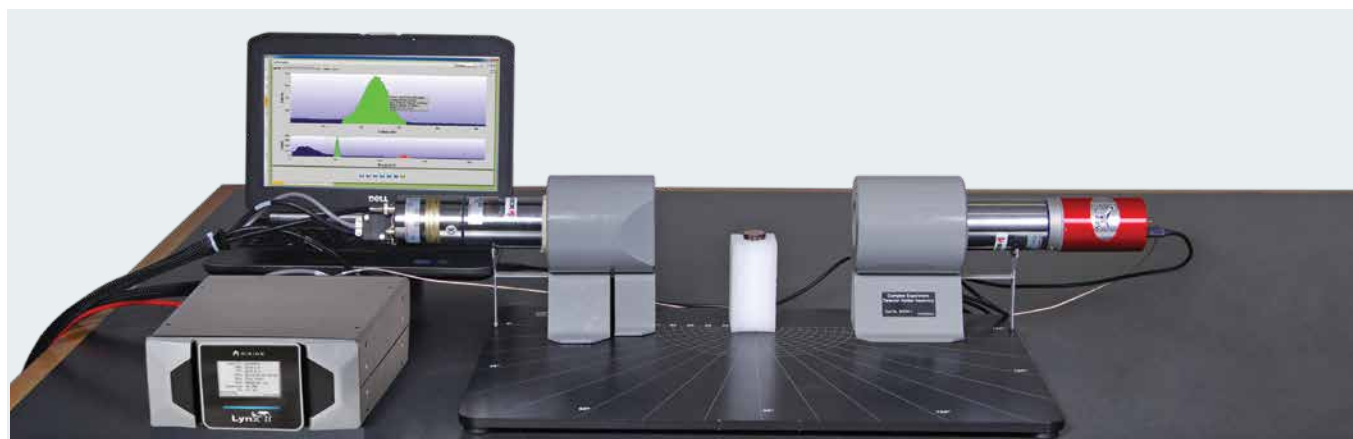

Gamma Spectroscopy Products



LABKIT Nuclear Science Experiments for Teaching Laboratories

FEATURES

- Turn-key solutions for 12 gamma nuclear science experiments
- Easy to order, set-up and use
- Cutting edge digital equipment for these and other custom experiments
- Two kits (Basic scintillation-based and Advanced HPGe-based) allow for easy planning and budgeting
- Basic Kit supports Experiments 1 – 5
- Advanced Kit adds to Basic to support Experiments 6 – 12
- Free lab manual includes all information needed to set up and perform the exercises

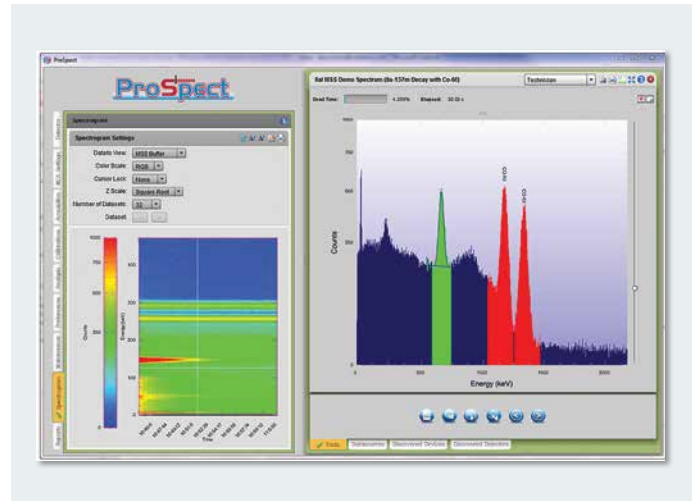

S600C ProSpect® Gamma Spectroscopy Software

FEATURES

- Gamma Spectroscopy Software with an ergonomic, intuitive user interface
- Rapid connection to devices through 'Discover' functionality
- Compatible with Osprey and Lynx DSPs
- Full acquisition mode support, including all the advanced modes of the Lynx and Osprey
- Supports ProSpect XML-based and Genie™ .CNF data storage format
- Streamlined export functionality to CSV format

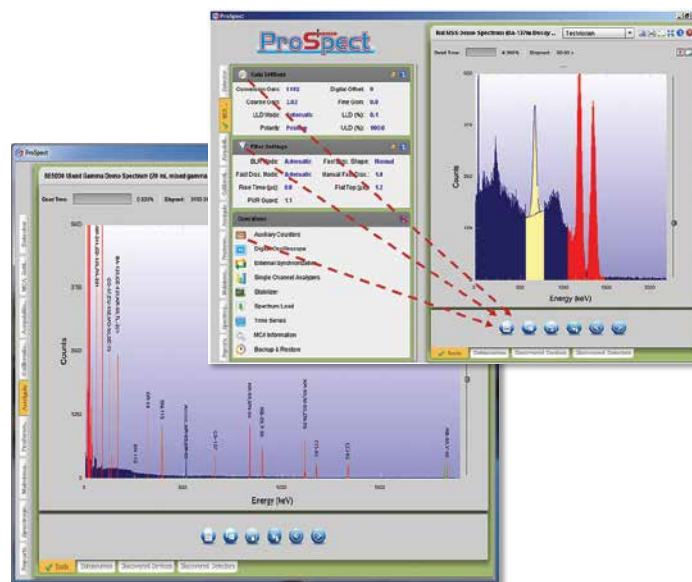

HPGe Detector Configurations for Nuclear Physics Research



Euroball Clover Detector 4x50x70 a great detector success designed by Mirion in early 90s with more than 130 identical detectors delivered worldwide.

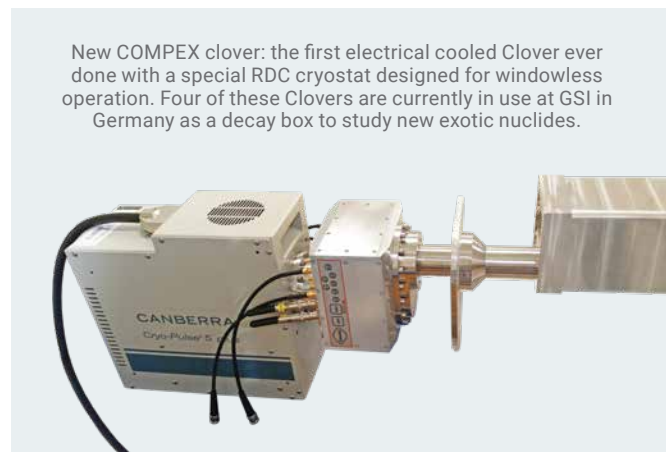

New COMPEX clover: the first electrical cooled Clover ever done with a special RDC cryostat designed for windowless operation. Four of these Clovers are currently in use at GSI in Germany as a decay box to study new exotic nuclides.

Clover™ Detectors Array of Four HPGe Detectors

FEATURES

- Clover Array-Detector design consists of four special shaped Ge crystals for a close array – with or without segmentation of the individual crystals
- Excellent energy and timing resolution due to dedicated crystal quality and low electrical noise electronics
- 130% relative efficiency in addback mode with a Clover 4x50x70. More is achievable with bigger crystals.
- Can address applications where highest efficiency or MDAs are required
- Low background configurations available with specifically selected materials for their radio-purity
- Thin entrance window for extended energy range to low energy photons available on request.
- Optional electrical cryocooling for LN₂-free operation

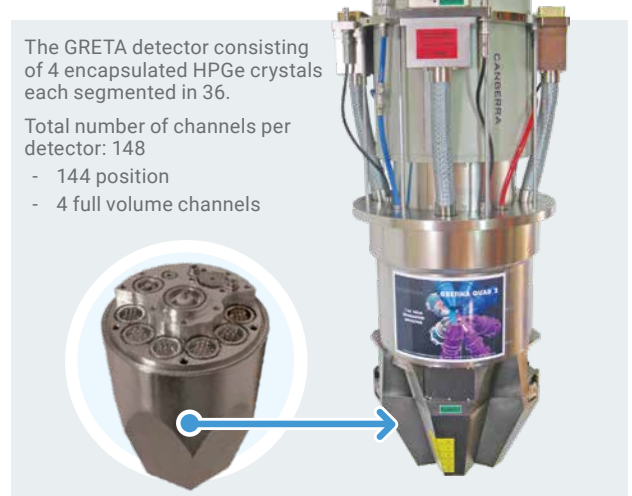

The GRETA detector consisting of 4 encapsulated HPGe crystals each segmented in 36.

Total number of channels per detector: 148

- 144 position
- 4 full volume channels



The Euroball Cluster detector is consisting of 7 encapsulated HPGe crystals. Mirion delivered 180+ individual capsules for Euroball Cluster detectors and Miniball at CERN.

The photo shows a design for JAEA: only the center crystal is segmented in six the surrounding capsule are not segmented.

High efficiency HPGe Array Solutions

FEATURES

- Up to seven HPGe crystals in one cryostat
- Encapsulation techniques for a modular design easy to handle in case of maintenance.
- At request segmentation of the outer contact of the individual crystals
- Embedded low power and low noise preamplifiers with fast rise time.
- Special irregular hexagonal shape to accommodate a complete 4 PI detection ball consisting of only HPGe material where Veto scintillator detectors such as BGO/CSI are no longer needed due to the close HPGe array detector system.

HPGe Detector Configurations for Nuclear Physics Research continued

Segmented Coaxial Ge Detectors for Position Information

FEATURES

- For gamma tracking, polarimetry, Doppler effect correction, β decay suppression
- Longitudinal and transversal segmentation of the outer contact by photolithography (up to 36 segments), on various N-type crystal geometries
- No dead zone or absorbing material between segments
- Monolithic or multielement segmented detectors
- Reliable segmentation technology over three decades not sensitive to heat cycling nor neutron annealing operation in-situ.
- No measurable crosstalk effects
- Increased granularity of multi-detector systems
- Localization of the interaction and gamma-ray tracking capability through coincidence between internal core signal and segment contact signals.

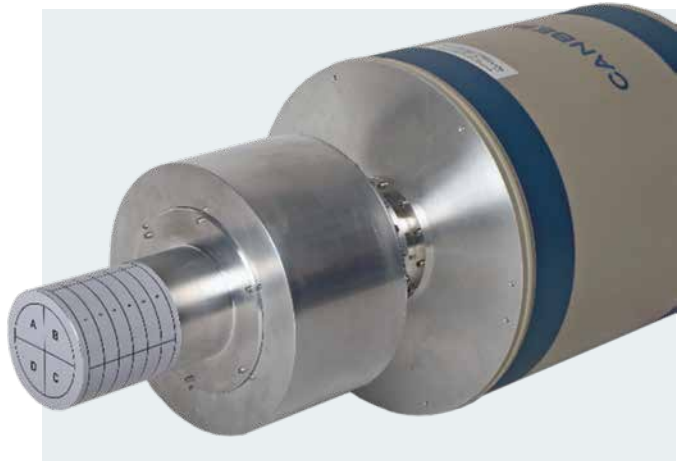

APPLICATIONS

- Nuclear physics:
 - Doppler effect correction
 - Multiple site energy deposit and β decay suppression
 - Polarimetry
 - Tracking
- Compton cameras – gamma imager: Gamma-ray sources location
- Compton suppression

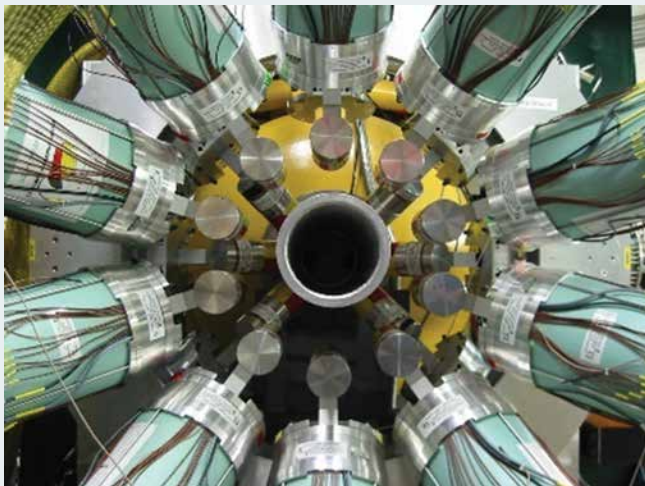

MSU "SeGA" system



CNS Ge array "GRAPE"

Inverted & Segment Coaxial Type Ge Detector

FEATURES

- Novel Germanium Detector technology for in-beam gamma-ray spectroscopy.
- Gamma-ray tracking for background suppression and multiple interaction analysis.
- Up to 20 segments including a central electrode (point contact) and surrounding segments as well inside the core.

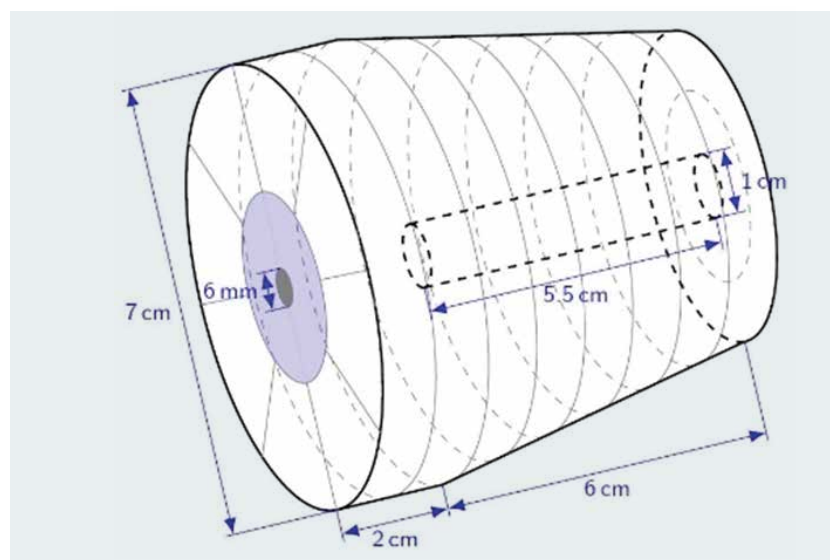

Specialty Ultra Low Background (S-ULB) Detectors

Mirion Technologies (Canberra™) has offered Ultra Low Background (ULB) detectors for more than four decades.

ULB detector performance can be significantly enhanced by new technologies to address demanding nuclear physics research like astrophysics with ultimate level of background as required in deep underground labs for low radioactive environmental samples.

COMMON MIRION S-ULB DETECTOR FEATURES

- ✓ Ultimate Level of Background.
- ✓ Customized HPGe crystals and electronics.
- ✓ Tailored cryostat to fit special constraints.
- ✓ Electrical cooling as a proven and mature technology for underground HPGe detector labs.
- ✓ New array detector systems for unprecedented detection efficiency.
- ✓ Novel Small Anode (SAGE) detector technology.
- ✓ New detector technology.
- ✓ Customized Well or true Well detectors for 4π detection geometry
- ✓ Minimized exposure to cosmic radiation due to Mirion storage cave with 800 mwe overburden.

CASE STUDY: BACKGROUND PERFORMANCE DIFFERENCE BETWEEN ULB & S-ULB DETECTORS IN AN UNDERGROUND LAB

This table below from the deep underground Lab Canfranc (LSC) in Spain provides the integral counts in ULB and S-ULB cryostats for a coaxial 400 cc P-type detector with “U” style cryostat.

Integral counts on a 400cc P type detector	Standard S-ULB (counts/kg/day)	Specialty S-ULB (counts/kg/day)
20-2700 keV	1932	190
40-2700 keV	689	179
60-2700 keV	641	165
100-2700 keV	598	143

By courtesy of Dr. Iulian Bandac - LSC

Background performance difference of BEGe6530 detectors at Boulby UnderGround Screening Lab (“BUGS”) in the UK with ULB and S-ULB cryostat grade assessment occurred in 2018:

- **Involved detectors:**
 - BEGe6530 with ULB cryostat (delivered in 2015).
 - BEGe6530 with S-ULB cryostat (delivered in fall 2017).
- Typical minimum activities (computed values) from the S-ULB detector at Boulby Underground Lab:
 - $^{210}\text{Pb} < 0.7 \text{ mBq/kg}$
 - $^{234}\text{Th} < 0.5 \text{ mBq/kg}$

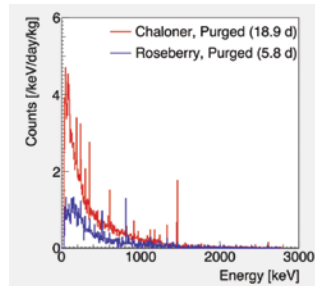

NOTE: There is not an insignificant amount of ^{58}Co (511 keV 810 keV 863 keV 1674 keV) and ^{57}Co (122 keV 136 keV) in the S-ULB detector background spectra in blue shown above. This is showing activation from being on the surface that will disappear with time due to the very short half life of ^{58}Co (71 days) and ^{57}Co (270 days).

Credit: 'STFC-Boulby Underground Laboratory' and the 'UCL, High Energy Physics Group'

During the LZ (Lux Zeplin) collaboration meeting Dr Cham Ghag from the University College London (UCL) compared the Mirion BEGe6530 detector in S-ULB cryostat with two world known reference detectors homemade specifically by MPI in Heidelberg for the Gran Sasso underground lab (LNGS) in Italy. It is important to highlight how close the Mirion S-ULB detector (called Roseberry) comes to the GATOR and GeMPI detectors recognized as world reference detectors, with respect to background performance.

Energy [keV]	Chain/nuclide	Counts/day		
		Gator	GeMPI	Roseberry
239	$^{232}\text{Th}/^{212}\text{Pb}$	<0.5	–	<0.3
911	$^{232}\text{Th}/^{228}\text{Ac}$	<0.5	<0.2	<0.3
352	$^{238}\text{U}/^{214}\text{Pb}$	0.7±0.3	<0.5	1.1±0.4
609	$^{238}\text{U}/^{214}\text{Bi}$	0.6±0.2	0.50±0.45	0.6±0.3
1120	$^{238}\text{U}/^{214}\text{Bi}$	0.3±0.1	–	<0.3
1765	$^{238}\text{U}/^{214}\text{Bi}$	0.08±0.06	–	<0.3
662	^{137}Cs	<0.5	–	<0.3
1173	^{60}Co	0.5±0.1	0.6±0.4	0.8±0.3
1332	^{60}Co	0.5±0.1	0.6±0.3	1.2±0.4
1461	^{40}K	0.5±0.1	0.6±0.4	0.5±0.3
2615	$^{232}\text{Th}/^{208}\text{Tl}$	0.2±0.1	–	<0.3

“Roseberry” is a nickname of a Mirion BEGe6530 with S-ULB cryostat (delivered in fall 2017)

“GATOR” (2010) and “GeMPI” (2005) are nicknames of 400 cc HPGe detectors with highly customized cryostat designed by MPI scientists in Heidelberg for the Gran Sasso underground Lab in Italy.

Credit: 'STFC-Boulby Underground Laboratory' and the 'UCL, High Energy Physics Group'



S-ULB Specialty Ultra-Low Background Cryostats

FEATURES

- Cryostat designs using selected grades of materials and tailored to the specific requirements
- Large detectors available (up to 910 cc)
- Custom designs to fit existing shielding constraints
- Selected materials like fresh OFHC copper or high-purity aluminum
- Compact endcap design accommodating scintillator guard detectors in close proximity
- Can be used with standard or array detectors
- 14 detector elements of 70% relative efficiency
- Global relative efficiency 980%
- High sensitivity measurement of U + Th contamination (see table to the left)

APPLICATIONS

- Assay of MoO₃ enriched powder
- Rare decay exploration like ^{180m}Ta with T1/2 > 4,5 1016 years).

Isotopes	Peak(keV)	Efficiency (%)	
²³² Th	²²⁸ Ac	911	5.8
		968	5.5
	²¹² Pb	238	9.7
	²¹² Bi	727	6.8
		2616	2.0
²⁰⁸ Tl	583	4.7	
	860	4.7	



1kg Small Anode Ge detector with preamplifiers on both contacts for neutrino search

SAGE™ Small Anode Germanium Detectors

FEATURES

- Large crystal sizes: 1.5 kg or larger
- Typical energy resolution 50 eV (FWHM with pulser)
- Energy threshold of ~150 eV
- Complex assemblies of several detectors in S-ULB probes to be dipped directly in LN₂ or LAr
- One or two preamplifiers per crystal (readout on both contacts for signal vetoing)
- Compact front cryostat without any flange for close veto detector operation
- Electrical cooled SAGE for LN₂ free operation without any compromise on performance
- Also available as a SAGE Well detector providing best noise threshold in a 4π detection geometry with optimized well sizes

Silicon Detector Configurations for Nuclear Physics Research

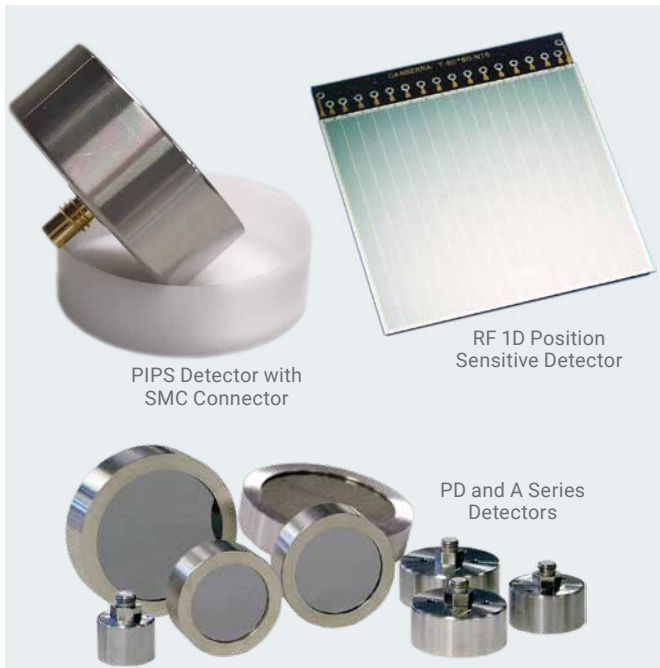

PIPS Detector with SMC Connector

RF 1D Position Sensitive Detector

PD and A Series Detectors

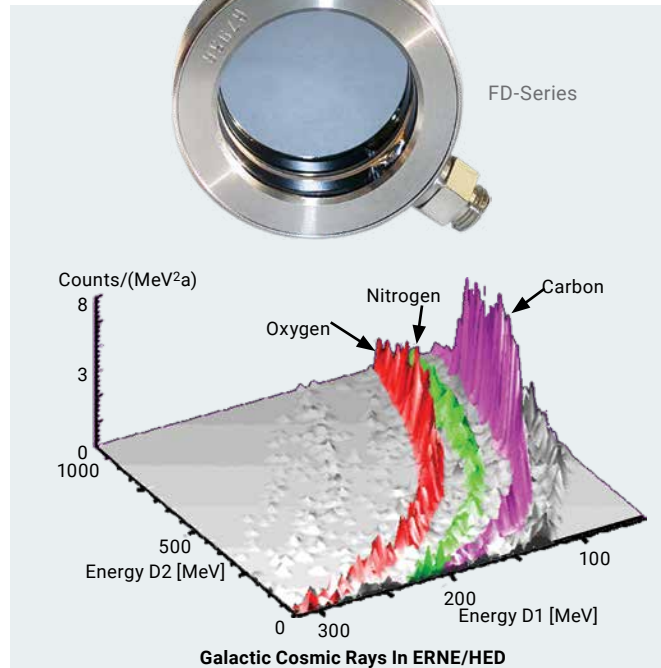

FD-Series

Galactic Cosmic Rays In ERNE/HED

PD, RF and A-Series PIPS® Detectors for Charged Particle Detection

FEATURES

- Excellent Resolution for Alphas, Betas, Protons, Electrons and Heavy Ions
- Entrance window < 50nm on all models
- Low Energy Beta's and Electron detection
- Single junction or strip, pixel detectors
- Assembles in housing or on PCB
- Connectors: Microdot, BNC and SMC; SMC typical for research applications

FD-Series PIPS Detectors for ΔE -Detection

FEATURES

- Thin window on entrance and exit
- Excellent resolution performance
- Single junction or pixel detectors
- Assembles in housing or on PCB

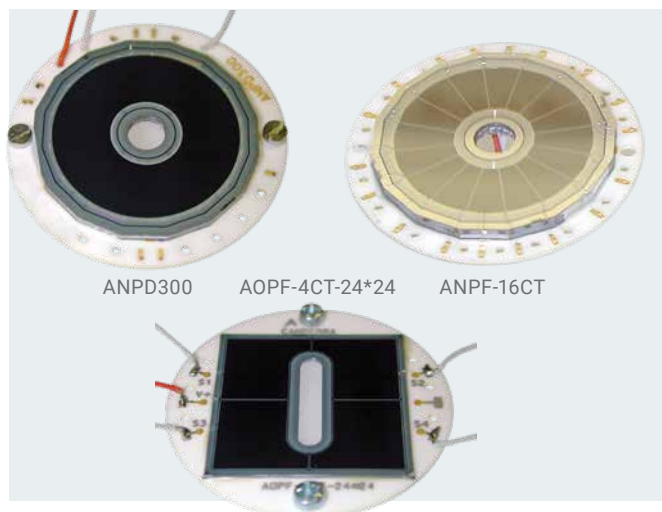

ANPD300

AOPF-4CT-24*24

ANPF-16CT

Silicon Photodiodes for Beam Monitoring

FEATURES

- Single or multiple junction on ceramic board
- Thin junction entrance window: <50 nm
- Low dark current, typically below 1 nA/cm²
- No optical window

X-Ray Detectors for Synchrotron Applications



64 and 100 pixel array

Monolithic HPGe Pixel Detectors

FEATURES

- Pixel sizes of 5x5 mm² and 8x8 mm² in arrays from 3 - 100 pixels on a single substrate
- Only technique offering 100% beam coverage
- Design allows the highest throughput electronics and outstanding energy resolution with excellent EMI shielding

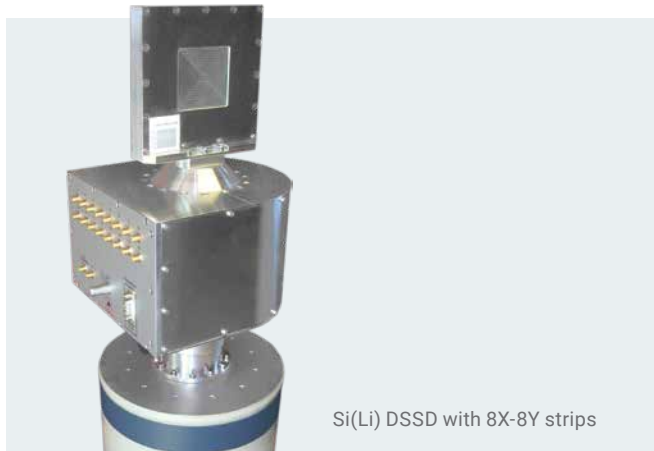

Si(Li) DSSD with 8X-8Y strips

DSSD HPGe Double-Sided Strip Detectors

FEATURES

- HPGe planar detectors for interaction localization
- X and gamma radiation imaging
- Compton camera using crystals stacked in a single cryostat
- No measurable crosstalk effect



5 x 50 mm² Ultra-LEGe with Retractable, Multi-Attitude Cryostat

18 x 50 mm² Ultra-LEGe with Electrically refrigerated cryostat

Discrete Single and Array Detectors HPGe

FEATURES

- Single or 2 - 32 individual HPGe elements
- Energy range: LEGe (3 keV and up); Ultra-LEGe (1keV and up)
- Windowless cryostats available for Ultra-LEGe energy sensitivity down to 300 eV
- High resolution even with very short pulse processing times



7-Element Array

13-Element Array

X-PIPS™ Series Detectors for Photon Detection (From Near UV to 30keV)

FEATURES

- Silicon Drift Detector (SDD) technology
- Pioneers in large area silicon drift detectors (CERN Alice)
- FET or CMOS preamplifiers
- Single element and 7- to 13- element arrays
- Pulse-tube cryo cooling
- Industrial manufacturing fully in house

Custom Detectors for Space and OEM Applications

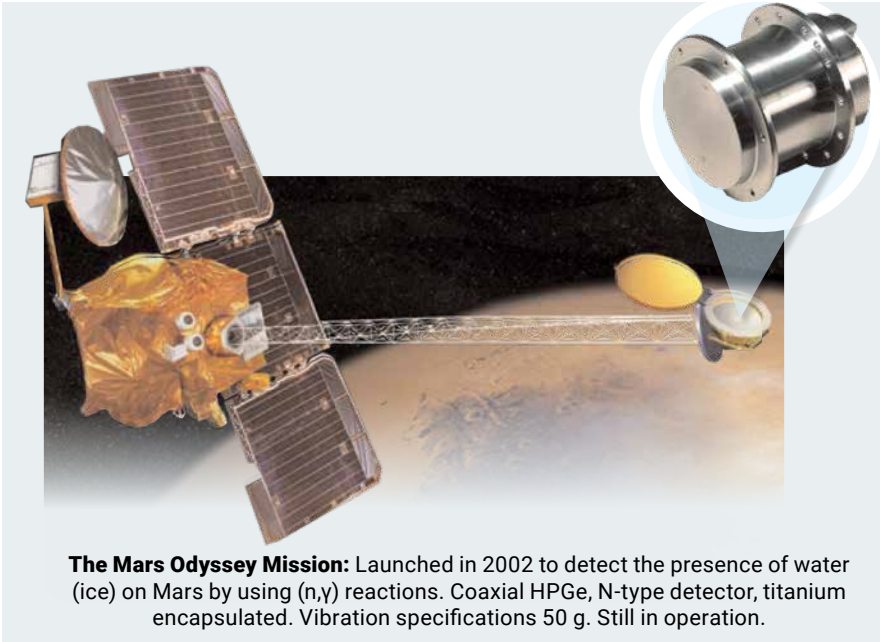

The Mars Odyssey Mission: Launched in 2002 to detect the presence of water (ice) on Mars by using (n, γ) reactions. Coaxial HPGe, N-type detector, titanium encapsulated. Vibration specifications 50 g. Still in operation.

Ruggedized HPGe Detectors for Space Exploration

APPLICATIONS

- Suitable for stratospheric balloons, space telescopes and satellites
- For accurate gamma cartography in galaxies (study of supernovae, black holes, etc.)
- Advanced encapsulation, ultra-high vacuum, waterproof and shock absorption design allows survival in the harsh environment of space
- Shock proof capability (100g) to survive vehicle take off
- Remote neutron repair ability
- Compatible with electrical cooling
- Mission examples: Mars ODYSSEY, Integral-SPI, CLAIRE Stratospheric balloon, SELENE Lunar orbiter

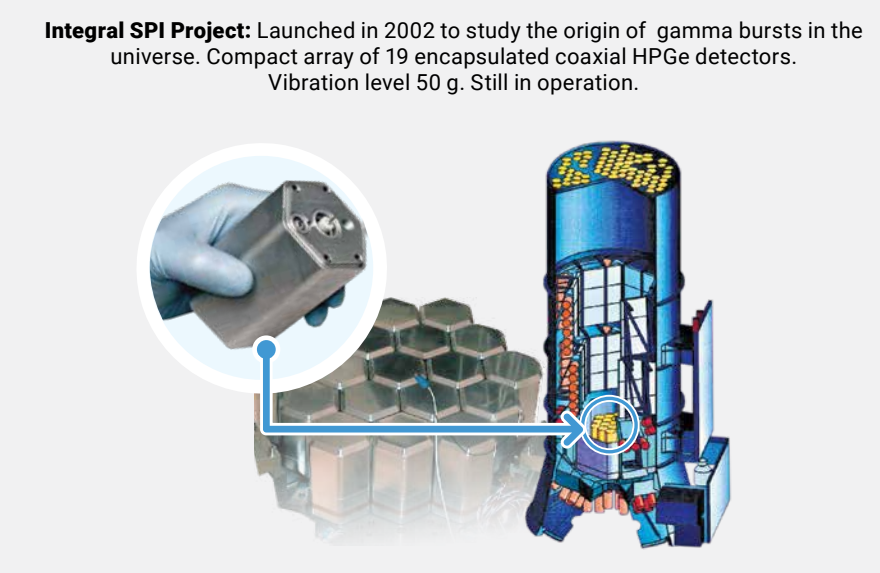

Integral SPI Project: Launched in 2002 to study the origin of gamma bursts in the universe. Compact array of 19 encapsulated coaxial HPGe detectors. Vibration level 50 g. Still in operation.

Encapsulated Ge Detectors

FEATURES

- For compact construction of multi-element detectors for gamma-ray applications
- For very large efficiency and solid angle coverage
- For high sensitivity and low detection limit gamma-ray spectroscopy even in harsh environments
- Easy annealing in standard ovens, without pumping, in case of radiation damage
- In situ annealing in space applications
- Long detector life time
- Large choice of shapes (pentagonal, hexagonal) for compact matrix assemblies
- Essential for complex cryostat development, particularly with segmented detectors
- Total reliability Ultra High Vacuum technology
- Easy detector handling and exchange



Selene (JAXA) Lunar orbiter mission "KAGUYA". Mission duration: one year. Encapsulated coaxial HPGe detector for the GRS. The GRS had an excellent energy resolution 20 times superior to those used in past lunar missions.

PIPS Detectors for Space Exploration

FEATURES

- Thickness: 200 to 500 μm
- Anti-reflective coating with QE > 80%
- Low dark current and direct coupling to scintillator
- Extremely rugged and low power requirement
- Awarded by NASA for the contribution to the Mars ROVER MSL Rad project
- PIPS detectors are deployed on the following current or recent missions:
 - JUICE mission exploring Jupiter's moons, STEREO and DOUBLE STAR studying solar storms, MESSENGER studied Mercury, NEW HORIZONS passed Pluto to outer space in a second extended mission, JUNO exploring Jupiter

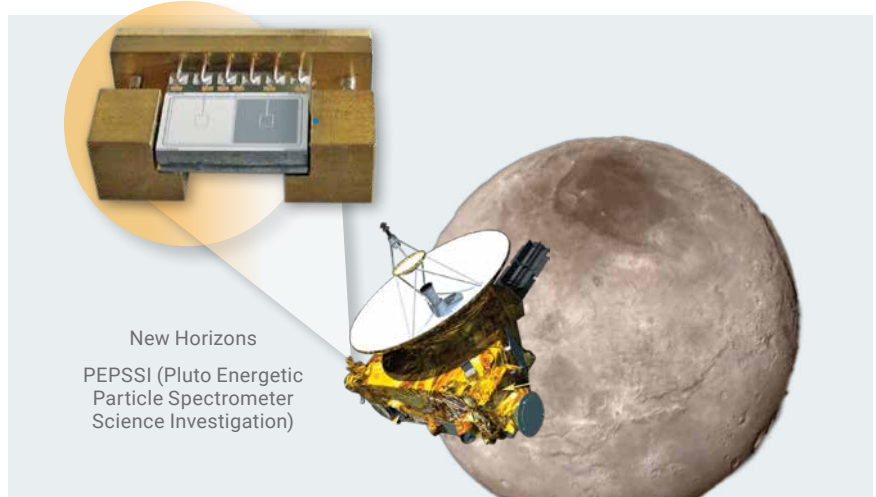

OEM Solutions for XRF-XRD-EDX Benchtop and Handheld

FEATURES

- Silicon Drift Detector (SDD) product range is targeted for integration in handheld and benchtop XRF systems
- All products are developed, designed, manufactured and assembled in house to customer specifications
- Includes compact preamplifier
- JFET or CMOS based front stage amplification



In Situ Measurement

In situ gamma spectroscopy is a valuable tool for supporting applications such as decontamination and decommissioning (D&D) at nuclear facilities.



These measurements save money and time when compared to the conventional process of extracting samples and sending them to a remote laboratory for analysis.

ISOCS™ SYSTEM

The in situ measurement product line includes a full complement of gamma spectroscopy systems and detector technologies from hand-held scintillation detector spectrometers to cart-based, high resolution HPGe spectroscopy systems. The products cover a full range of portability, sensitivity and spectral resolution capabilities and form the basis for Mirion's automated waste assay systems. Systems are also available with a simplified user interface for non-expert operators taking field measurements.

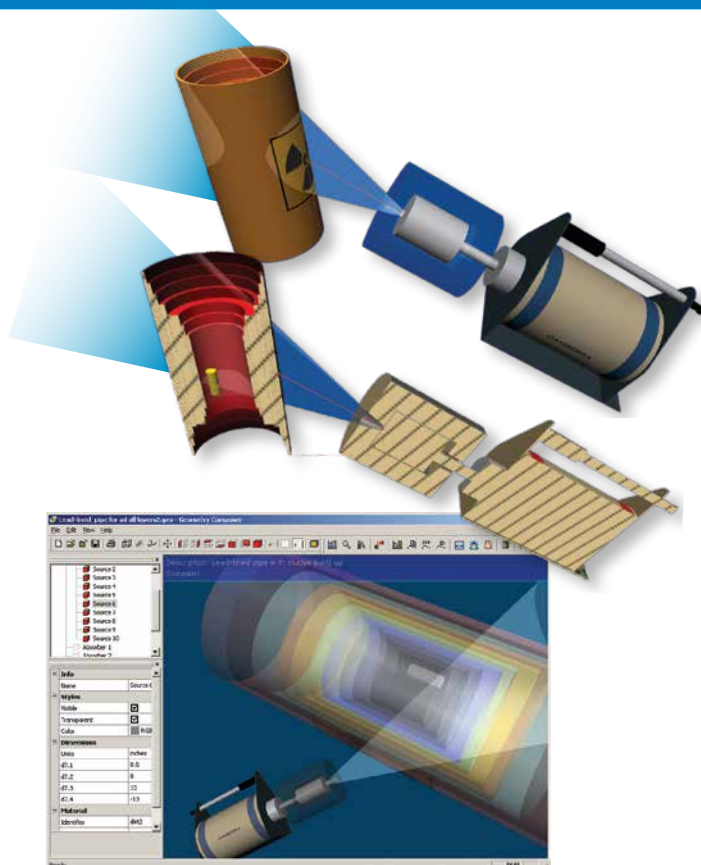

For in situ measurements, the ISOCS™ system has become the most widely accepted measurement tool in the world. The ISOCS system is commonly used to measure contaminated materials and areas, both in place or after removal from the facilities. It is also used for final status measurements to allow release of areas for general use, or general demolition activities.

The ISOCS sourceless efficiency calibration software can be used with instrumentation from hand-held spectrometers to large, multi-detector assay systems to provide both qualitative and quantitative results meeting stringent user requirements and governmental regulations.



Aegis™ Transportable HPGe Spectrometer

FEATURES

- Integrated solution combining a thermal cycle-free HPGe detector system, MCA and electronics platform
- Portable and battery-powered with choice of electrically-cooled HPGe detector:
 - Detector options: BE5030, GX40 and GC40 with or w/o RDC-6 Remote Detector Chamber
 - RDC-6 is compatible with ISOXSHLD Cart and with standard laboratory lead shields
- Built-in GPS and dual, hot-swappable batteries
- Wired or wireless communication to host computer
- Operation from -20°C to 50°C without cooling fans
- IP65-rated enclosure enabling operation in harsh environments
- Access to system through web browser
- Web UI allows:
 - Setup, diagnostics and maintenance
 - Spectrum viewing
 - Firmware updates
 - User account and network management
- Genie software used for data acquisition and analysis
- ISOCS™ characterization is available radionuclide activities to be calculated for complicated geometries

MicroGe with Supply Station, Lynx II and Genie Software for Windows PC



MicroGe™ Compact HPGe detector

FEATURES

- High count measurement in extreme environments
- Compact and lightweight portable Ge
- Can be used almost anywhere
- Thermal cycle free
- Small HPGe crystal: 0.1 % relative efficiency
- Electric cooling system (lightweight, short cool-down time power saving)
- Ultra-low noise electronics circuit
- System design options:
 - Collimator
 - Watertight housing
- Hardened vacuum allowing partial thermal cycles

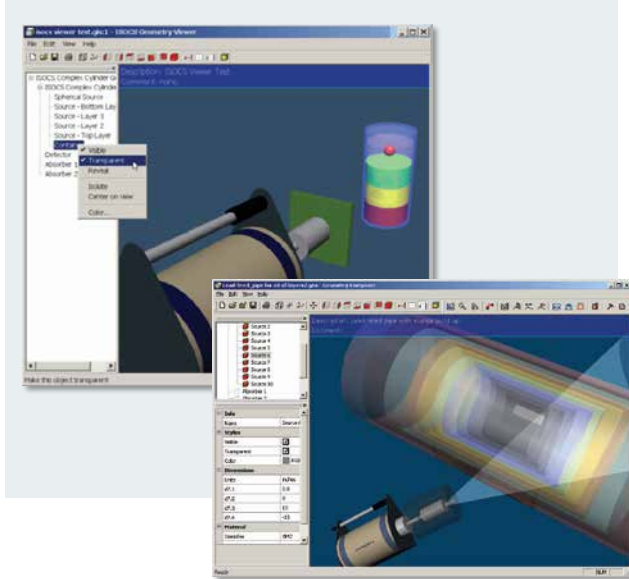

S573C ISOCS™ Calibration Software

FEATURES

- Eliminates the cost of purchasing, tracking, and disposing of radioactive standards
- No radioactive efficiency source standards needed for accurate efficiency calibrations
- Calibrations valid from 10 to 7000 keV
- Calibrations valid from detector face out to 500 meters
- Sample size can be point-like, or up to 500 meters in size
- Advanced Collimator designs include liners and back shielding
- Calibrations accurate at any angle from detector, not just on center line
- Operates with germanium, scintillation and CZT detectors characterized by Mirion
- Ideal for In Situ applications, where large and various sample types are often encountered
- 3D visualization speeds geometry creation and error identification
- Uncertainty Estimator and Assay Planning tool
- Custom templates can be provided to meet special application needs
- Multi-Efficiency program allows creation of compound efficiencies for multiple detectors, multiple locations or multiple sources
- Compliant with 2009 U.S. NRC Regulatory Guide 1.21

ISOXSHLD ISOCS™ Shield Systems

FEATURES

- Portable Germanium detector shield system for in situ assays
- Compatible with the Aegis Transportable HPGe Spectrometer and LN₂-cooled HPGe detectors
- Includes 25 mm and 50 mm thick lead shields
- Reduces interfering 1000 keV radiation by a factor of 7.5 (25 mm) and 60 (50 mm)
- Modular design for easy handling
- Includes 30°, 90°, and 180° collimators (each thickness) plus solid end caps for background measurements
- Includes a rear shield set (requires RDC option on detector)
- Wheeled mounting stand with brakes for ease in moving the shield from one sample to the next
- Large wheels for easy movement: 40 cm (16 in.) at rear, 20 cm (8 in.) in front
- Upper and lower detector mounting positions, with 180° detector rotation at either location
- Easy to assemble and to change detector positions
- Built-in laser aiming device
- Components from 25 mm and 50 mm shields may be combined to build a sample counting chamber





DA-PRO with GR1 Spectrometer and Shield

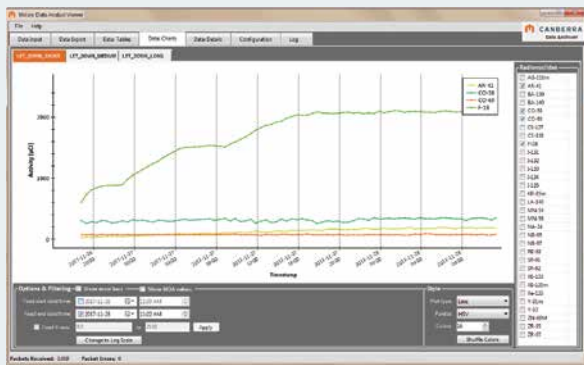

DA Prospector Nuclide Trend Plot

Data Analyst™ Continuous Monitoring Solution

FEATURES

- Portable CPU platform including embedded Genie and ISOCS™ software algorithms
- Can perform multiple analyses simultaneously with different count times, nuclide libraries, and analysis parameters
- Completely unattended operation once installed and turned on
- Compatible with:
 - Lynx® DSA and HPGe or scintillation detectors
 - Osprey® Tube Base MCA and scintillation detectors
 - GR1™ family of Compact CZT Spectrometers
- Supports EcoGamma™ monitor for local dose rate
- Can also be used for trending of non-spectroscopic sensors (temp., pressure, flowrate, etc.)
- Wired Ethernet, USB and wireless communications
- Internal memory for storage of months of spectral results
- Web-based GUI for control and data review
- DA-Prospector™ Application used to display nuclide results trends from live or historical data
- Compatible with the Horizon® Supervisory System for monitoring DA-PRO systems
- Provided with:
 - Custom ISOCS modeling and efficiency calibration based on detector and sample geometry to be used
 - Customized analysis workflow configurations to best suit the measurement
- Can be used for continuous radiation monitoring of effluent stacks, liquid or gas in pipes, tanks, waste processing systems, environmental or emergency conditions, etc.



SPIR-Ace™ RIID with the GenieXPort™ Application

FEATURES

- SPIR-Ace Radionuclide Identification Device (RID) with GenieXPort application for Genie™ compatibility
- Ultra-fast and accurate compact identifier
- Simple operation with versatile alarm modes
- Automatic sourceless gain stabilization
- Radiological performance exceeds current standards for RIIDs and RIDs
- Live data transmission and reachback capability
- Optional alpha/beta probe and integrated neutron detection
- Battery life: 4.5 to 11 hours, depending on display use
- Onboard GPS for trajectory and mapping
- Remote display and control via web browser
- SPIR-SPEC™ package includes:
 - SPIR-Ace Radionuclide Identification Device
 - GenieXPort application providing compatibility with Genie software for proven activity determination and reporting
 - Generic ISOCS™ characterization of the SPIR-Ace detector
 - Preloaded efficiency calibrations for easy nuclide quantification
- Use ISOCS software to create efficiency calibrations for unique geometries that can be loaded to the SPIR-Ace device as well

FoodScreen™ Radiological Food Screening System

FEATURES

- Rapid screening of processed or raw food products for key ¹³¹I, ¹³⁴Cs and ¹³⁷Cs nuclides
- Clear, immediate indication if any nuclide-specific maximum permissible concentrations are exceeded
- Transportable using compact and wheeled detector shield
- Supports wide range of samples including 1 L Marinelli, metal food cans, beverage cans and plastic containers
- Completely battery-powered – from laptop PC's USB port
- Room temperature operation with option for temperature stabilization if measurements will be made outdoors
- Powerful Genie™ 2000 spectroscopy algorithms teamed with the intuitive Genie-FoodPro™ user interface designed specifically for this application
- Turn-key system is provided ready to count, calibrated for typical sample types in a range of common sample containers
- On-site training and/or start-up assistance available from local Mirion representative



Genie-FieldPro™ Gamma Spectroscopy Sample Counting Software

FEATURES

- Simplified user interface for gamma sample counting by non-experts
- Uses powerful and familiar Genie analysis algorithms
- Sample count time and analysis automated by user selection of sample size and matrix
- Automated “Clear” or “Above action limit” results report generation
- Single click operation for background check and calibration check
- Automated sample data export to Apex-Gamma™ System for remote expert review
- Color-coded calibration check and background check status
- Calibration check and background check failure/overdue lockout
- Count-to-MDA acquisition option
- Can be used with any scintillation detector that is compatible with the Osprey Digital Tube Base
- Optional Camera and GPS integration

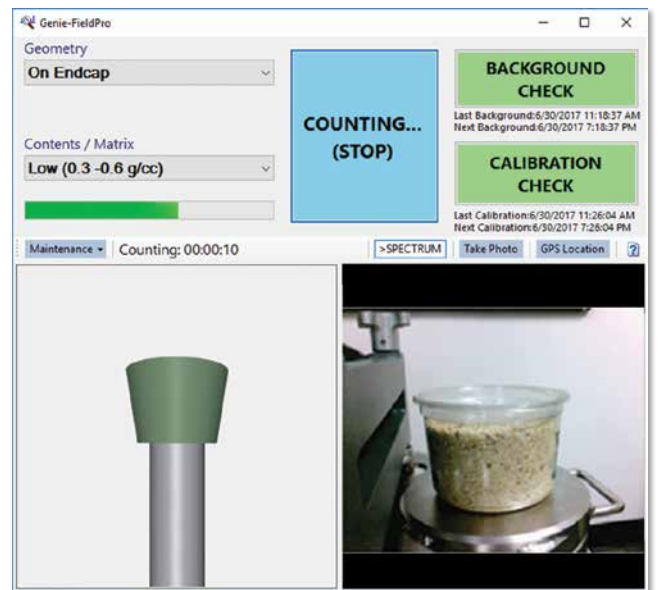

Waste Management and Special Systems

Waste disposal is a major concern, whether a facility is operational and routinely generating radioactive wastes or closed and undergoing decontamination and decommissioning (D&D).

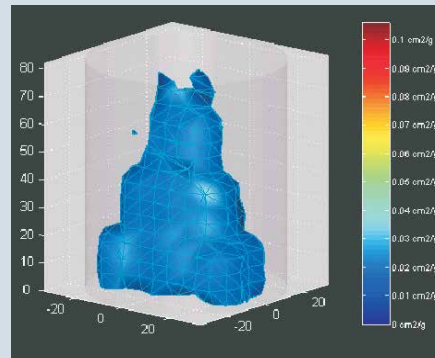
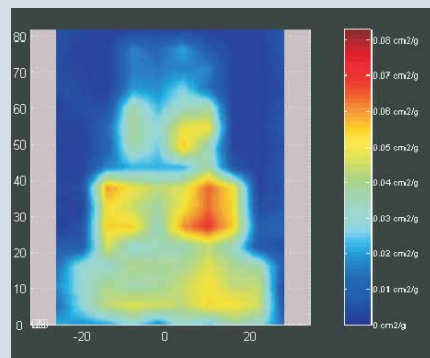

NDA 2000 Non-Destructive Assay Software and WM2900 Drum Scan

The ability to accurately measure and characterize the nature of radioactive waste is critical to minimize associated costs and environmental impact.

By working closely with nuclear facilities and regulatory agencies worldwide, Mirion has developed an advanced family of assay systems that can effectively measure materials in the widest variety of matrices and container geometries. In fact, Mirion has designed, built and operated waste assay systems for many years. This wealth of experience goes into all systems offered now and in the future.

For systematic waste characterization and disposal, a system including one or more Germanium detectors is recommended. Systems of this type include WM2100, WM2200 and WM2900 Series gamma scanners for drum or small boxed wastes. The WM2500 Series Gamma Box and Container Assay System is

appropriate for measuring large volumes of low to moderately contaminated material, such as debris from D&D operations, in a short amount of time. Additionally, the Hybrid K-Edge/XRF Analyzer is used by the safeguards community for routine special nuclear material inspections. All these systems offer excellent sensitivity along with simple, operation and built-in record keeping.

All items are integrated, tested and calibrated as a system before shipment. Mirion can offer standard or customized solutions for performing gamma, neutron or gamma and neutron waste or safeguards measurements to suit any application. The systems described in this section are just a few examples.





Series Q2™ Qualitative and Quantitative Gamma Waste Assay System

FEATURES

- Provides qualitative and quantitative gamma assays for waste in 208 L (55 gal) drums or similar sized boxes
- Sensitivity better than 370 Bq (10 nCi) for 208 liter (55 gal) drums
- Factory calibrated for turnkey operation, and includes QA check source and holder
- Low background 10 cm (4 in.) steel shield
- Automatic weighing system for matrix attenuation corrections due to sample density
- PC-based control and analysis system featuring the user-friendly Canberra NDA 2000 Waste Assay Software package



Auto Q2 Low Level Waste Assay System

FEATURES

- Complete quantitative gamma analysis for fission/activation products or TRU radionuclides
- Multiple large coaxial or broad energy detectors for optimal performance
- PC-based control and analysis system featuring the user-friendly Canberra NDA 2000 Waste Assay Software package
- ^{239}Pu detection levels <1 mg
- Container sizes up to 208 L (55 gal); optional up to 400 L
- PLC-based electromechanical control system with optional capabilities including:
 - Automatic weighing system
 - Automatic attenuators
 - Automated conveyor system



CP-5 Plus Cryostats can be used for LN₂-free detector cooling

WM2200 Series Segmented Gamma Scanner

FEATURES

- Accurate quantification of gamma emitting waste
- Multiple correction techniques for matrix attenuation
- Self-absorption correction algorithms for lump correction
- Calculates Pu and U isotopics using optional MGA code
- High activity versions available for surface dose rates up to 1.0 Sv/h (100 R/h)
- PC-based control and analysis system featuring the user-friendly Canberra NDA 2000 Waste Assay Software package



TGS™ Tomographic Gamma Scanner

FEATURES

- Most accurate gamma measurement available for waste drums
- Optimal measurement range is for gram quantities of plutonium or uranium
- Available in manual, semi-automated, and fully automated modes
- Options available for high activity measurements up to 1.0 Sv/h (100 R/h)
- Interactive graphics package provides color plots of hot spots in container
- PC-based control and analysis system featuring the user-friendly Canberra NDA 2000 Waste Assay Software package

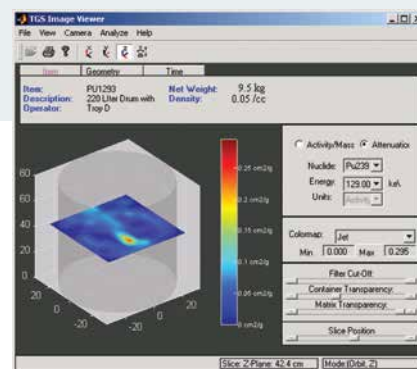



WM2500 Modular Gamma Box and Container Counter™

FEATURES

- Performs full gamma spectroscopy and accurately characterizes containers of waste
- Saves time and labor by assaying waste in a large container or its shipping container
- Modular design can be configured for samples from B-25 (1 x 1 x 3 m³) boxes through ISO shipping containers
- Fully assays a B-25 box in 30 min. and an ISO container in 2-3 hours
- 0.01 Bq/g (0.3 pCi/g) typical detection limit for a B-25 box
- Available with manual, powered, or automatic conveyor systems for sample handling
- PC-based control and analysis system featuring the user-friendly Canberra NDA 2000 Waste Assay Software package



HKED Hybrid K-Edge/XRF Analyzer

FEATURES

- For routine inspections by the international safeguards community
- Non-destructive, on-site analysis of heavy elements in a wide variety of materials, including highly radioactive samples
- Analysis for several elements simultaneously
- No sample preparation required
- Only 2 mL of the sample material is required
- Precision typically better than 0.5%
- Typical assay time of 5 to 20 minutes
- Hybrid K-Edge software offers fully integrated operation, measurement, calibration and analysis capability for HKED systems
- Capable of analyzing U:Pu 1:1 MOX (high concentration – generalized KED analysis)



NDA 2000™ Non-Destructive Assay Software

NDA 2000 software is a complete acquisition, analysis and archival package for use with all Mirion (Canberra) gamma waste assay systems and neutron counters. The software offers fully integrated gamma and neutron analysis for combined or sequential assay operations and is based on the Genie Spectroscopy Software Suite providing ease and flexibility of operation. Various counter arrangements, detector arrangements, analysis sequences, hardware control, and reports can be generated from the standard software. The software can be easily adapted to handle assay requirements changes.

Integrated gamma-neutron assay sequences can acquire data simultaneously, sequentially or independently. Following completion of both measurements, the neutron and gamma assay results can be combined automatically even if the measurements were performed days apart.

The Genie Quality Assurance software, required with NDA 2000, provides daily measurement checks on the system performance. The software can be configured to enforce the use of the quality control checks and ensure that system operating parameters are within the desired bounds.

FEATURES

- Supports all Canberra safeguards and waste assay systems
- Based on Genie software
- Supports neutron and gamma assay systems – both separate and integrated systems
- Provides full control of data acquisition electronics
- Controls automated assay system operation
- Menu structure for ease of operation
- Includes automated evaluation of different measurement modalities
- Customer editable report formats
- Multi-level password control

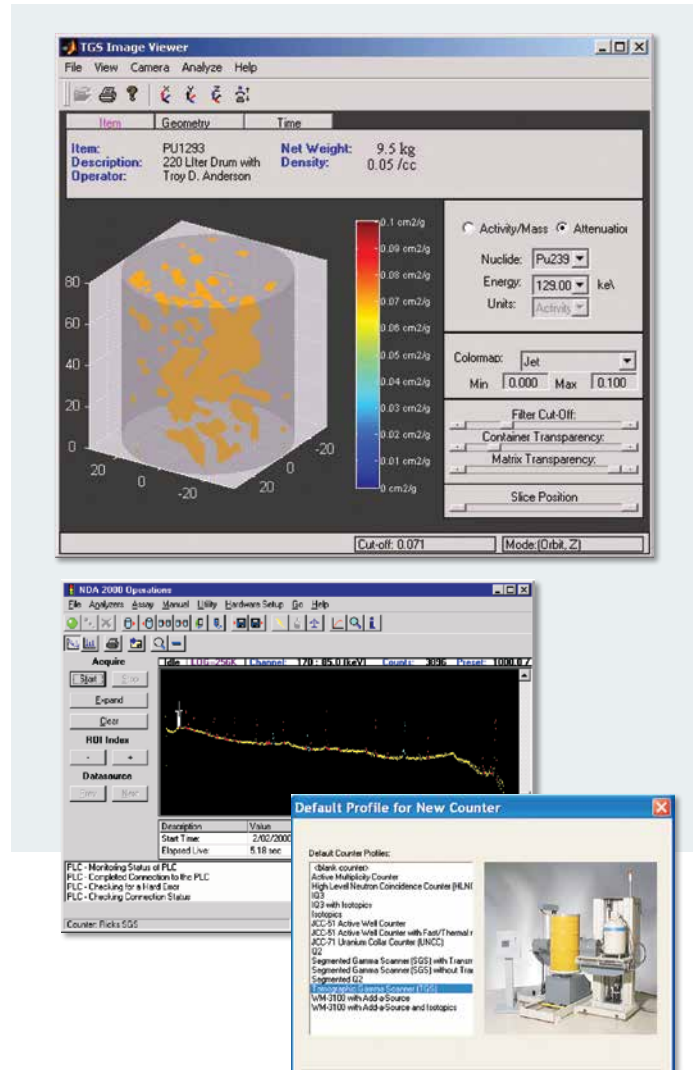

Customer Support Services



CUSTOMER SUPPORT AGREEMENT

Customized program designed around specific needs, including installed equipment support, mission critical activities, Calibration and Consulting Services.



CONSULTING SERVICES

Provide on-site and remote assistance in the areas of Programming, Procedure Writing, Calibration, System Audits, Performance Testing and Data Review.



TECHNICAL SUPPORT AND PRODUCT REPAIR

Local and regional offices to provide technical assistance, on-site repairs and product maintenance. Our community portal also provides you access to live updates to cases, and Mirion's Knowledge Base.

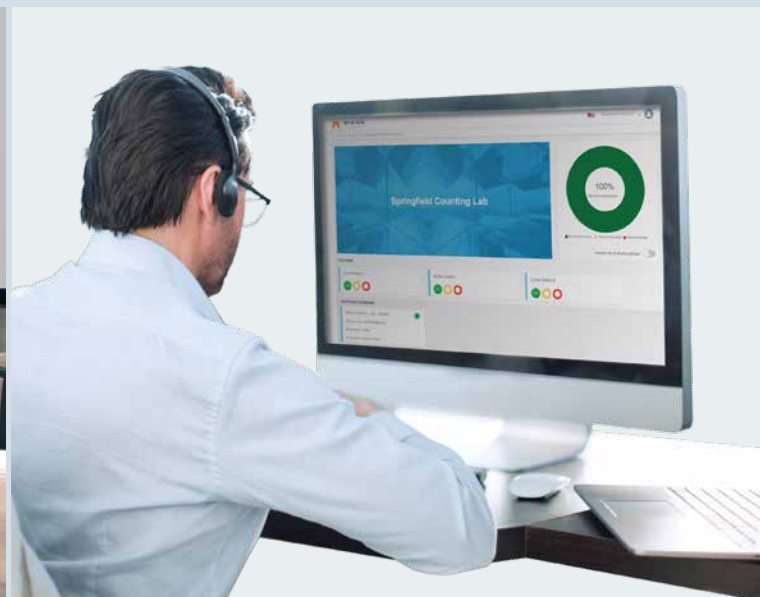



INSTALLATION

To maximize your efficiency, our Field Service Engineers ensure qualified installation of instruments and software, based on your application and environment.



TRAINING PROGRAMS

Courses cover fundamentals, applications, and in-depth product and software training. Choose on-site, in-house or virtual machine learning, as well as e-learning to accommodate busy schedules.



CALIBRATION SERVICES

We offer complete services using a variety of phantoms and sources (including fissile material) for Whole Body Counting, Gamma Spectroscopy, Waste Assay, Contaminations Monitors. Plus, we provide dose calibration of Health Physics and Neutron instrumentation.



Mirion Nuclear Services

INSTALLATION SERVICES

To maximize your efficiency, our Field Service Engineers ensure qualified installation of instruments and software, based on your application and environment.

REAL-TIME STATE OF HEALTH MONITORING

Designed to insure that your critical instrumentation is always ready when you need it, our real-time Lab-Pulse™ Services tracks and trends key parameters in your detectors, counting system electronics and count room environment to alert you and Mirion Service personnel that a problem may be on the horizon – even before it appears in your QC checks. Whether on-site or remotely observing monitoring equipment, our exclusive State of Health sensors deliver data to confirm of proper instrument operation. If your instrumentation begins to show signs of a future failure, a Lab-Pulse message will give you the earliest possible warning so your maintenance plans can be proactive instead of reactive.



PROFESSIONAL TRAINING SERVICES

Mirion offers a comprehensive portfolio of standard and custom training courses available at 10 training facilities in North America, the UK, and Europe or on-site at customer facilities. Courses cover fundamentals, applications, and in-depth product training and are presented by technical experts with professional training qualifications.

Our training courses provide incrementally progressive learning opportunities to new personnel and experienced users. Courses are flexible in terms of course content and length and are offered in classroom and laboratory environments for hands on experience.

We have also offer professional quality training content on-line and are expanding our on-line training continuously.

ROUTINE SYSTEM MANAGEMENT AND MAINTENANCE

Regular, scheduled maintenance allows you to maximize your up time by keeping equipment performing to original specifications and spotting potential problems before they adversely affect operations.

Mirion Customer Support Agreement (CSA) services range from field support and parts and repair coverage to continuous real-time monitoring and more. Whatever your uptime needs are, we can help – saving you time and money in the process.



CALIBRATION SERVICES

Complete calibration services are available using a variety of phantoms and sources (including fissile material) for Whole Body Counting, Gamma Spectroscopy, Waste Assay, Low Background Alpha/Beta Counting, Contamination Monitors etc. Our specialists can manage all aspects of the work, from preparation of risk assessments / method statements, to preparation of the final report and assistance with customer's documentation.

We can also provide comprehensive LabSOCS and ISOCS characterization and calibration services, providing NIST-traceable calibration verifications while relieving the burden of source acquisition, storage, and disposal.

PROCEDURE WRITING

Mirion's staff of scientists, health physicists, and engineering professionals is available for the development or review of plant procedures and programs.



PROGRAMMING

Our extensive applications engineering resources can support your unique needs to construct a solution to the specific application problem.

DATA REVIEW

Professional review services of measurement results can include:

- ✓ Complete administrative review
- ✓ Comprehensive technical review
- ✓ Comprehensive Quality Assurance review
- ✓ Data summarization
- ✓ Simplified presentation of program data
- ✓ Assessment of measurement results for items which cannot be dealt with by the normal system calibrations
- ✓ Recommendation for future action by the customer
- ✓ Recommendation for system enhancements/remedial action

A standard Data Review package includes:

- ✓ Written narrative
- ✓ Summary of data
- ✓ Individual analysis results

SITE SPECIFIC CUSTOMIZATIONS

Mirion's team of technical support engineers has decades of combined experience utilizing our flexible off the shelf solutions to create highly customized site-specific applications.

ROUTINE OPERATIONS

Mirion offers trained personnel to assist customers with staff augmentation from short-term projects to full time operators of specific systems. We have personnel with expertise in all areas of routine plant operations including:

- ✓ NDA Systems operation
- ✓ WBC operations
- ✓ ISOCS/site characterization
- ✓ Chemistry lab management
- ✓ Health Physics operation



PERFORMANCE TESTING PROGRAMS

A fundamental component in any laboratory Quality Assurance program is stringent performance testing. Mirion's technical services group has years of experience developing and maintaining world class methods and procedures, and in the performance assessment of radiometric systems according to national standards and best practice guidelines.

Our customers can leverage this experience in their performance testing programs for laboratory equipment and plant-installed radiometric assay systems.

Our services include:

- ✓ Complete Quality Assurance program development
- ✓ Development of performance standards for all phases of laboratory testing
- ✓ Development of inter-laboratory comparison check procedures
- ✓ Review of sample collection procedures
- ✓ Development and administration of qualification programs for laboratory personnel
- ✓ Independent oversight of laboratory QA testing protocols and results
- ✓ Provision of "Best practice" advice in operation of equipment
- ✓ Consulting as a 3rd Party reviewer of your radio-analytical methods and results
- ✓ Performance assessment for radiometric assay systems using measurement with "phantom" sample containers, supplemented by modeling

SYSTEM AUDITS

Periodic and planned audits, assessments and surveillances of systems and processes can be provided to assure compliance with regulatory and site requirements. These oversight activities are planned, performed, documented and reported to appropriate management personnel using approved written procedures.

The process consists of monitoring or observing to verify whether an item, activity or process conforms to specified requirements. These oversight activities can be performed on an almost unlimited number of topics; however Mirion specializes in counting practices, spectral interpretation methodologies, quality assurance, quality control practices and system management.



Empowering Progress Across Continents

Mirion Technologies combines innovative radiation safety technologies with unrivaled expertise, cultivated over decades of collaboration with reactor manufacturers and operators, nuclear fuel facilities, regulators, national labs (such as the U.S. DOE), nuclear institutes, universities, and national military/security organizations worldwide.

Trust us to provide the solutions and support you need to safeguard your valuable assets and ensure a secure and sustainable future.

 CORPORATE HQ (ATLANTA, GA)  MANUFACTURING SITES  SERVICE & SALES CENTERS

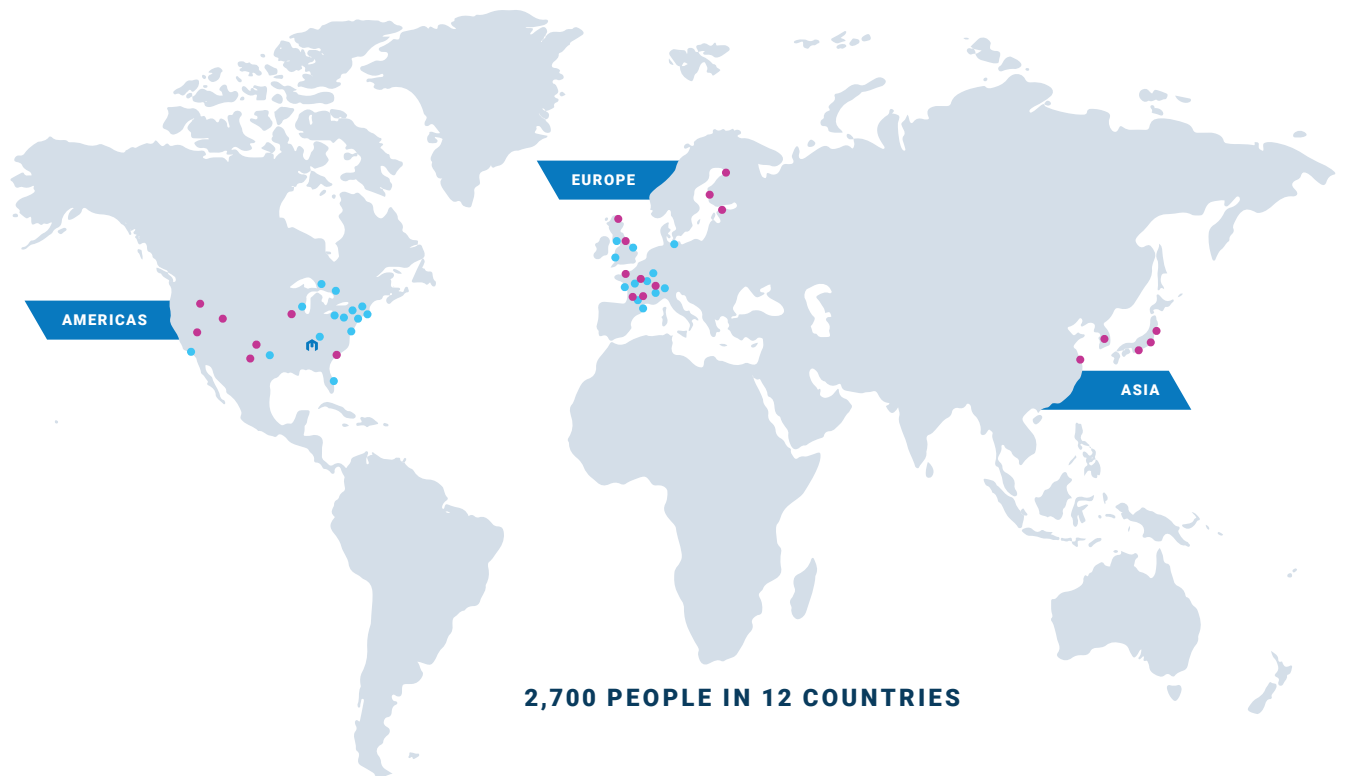



Protect What's Next™



MIRION
TECHNOLOGIES

Copyright © 2023 Mirion Technologies, Inc. or its affiliates. All rights reserved. Mirion, the Mirion logo, and other trade names of Mirion products listed herein are registered trademarks or trademarks of Mirion Technologies, Inc. or its affiliates in the United States and other countries. Third party trademarks mentioned are the property of their respective owners.