

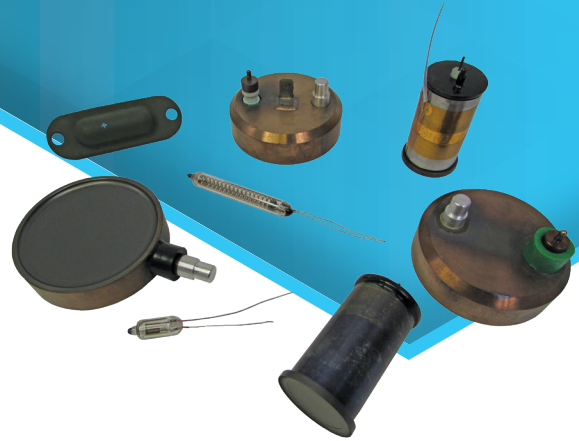

GM TUBES

Geiger Mueller

Detectors



FEATURES

• Product Reliability

The Mirion Geiger Mueller detector has been carefully researched and developed to provide a rugged, reliable, long-lasting means of monitoring nuclear radiation levels. These detectors offer guaranteed advantages, including manufacturing consistency, product reliability and competitive pricing. Many of our detector types are manufactured and tested to withstand rigorous shock and vibration per military standards.

All Mirion GM detectors comply with our stringent quality assurance policies, consistent with ISO 9001.

Our Warranty

- Mirion warrants that its Geiger Mueller detectors will be free from defects in materials and workmanship for a period of one (1) year from the date of initial shipment.

DESCRIPTION

Guaranteed Analysis

As an end user of Geiger Mueller detectors for over 60 years, we have successfully bridged the gap between technical conception, detector design and field application to achieve the quality performance you demand.

Consider the Source

More than six decades of nuclear instrumentation design enables us to incorporate quality and reliability into an outstanding line of Geiger Mueller detectors, including 2000 Series pancake detectors. We offer extensive experience as both a manufacturer and end user of all types of radiation detectors. Over the years, our detectors have met and exceeded customer needs in laboratory, military and harsh industrial environments.

Our Geiger Mueller detectors are the obvious choice for the discerning user. These detectors are built to exhibit superior performance, reliability and long-term stability. Our extensive product line provides direct (or near equivalents) for industry-standard detectors, including all versions of pancake detectors and frisker probes.

Manufacturing Excellence

Mirion's manufacturing operation has refined the development and production of GM detectors. We utilize state-of-the-art instrumentation and the finest equipment to monitor and control all manufacturing processes. Our painstaking attention to every detail ensures contamination-free assemblies. We use only the highest quality materials to fabricate critical detector components. Our adherence to stringent design parameters and quality assurance ensures performance that meets or exceeds exacting commercial and military standards.

Mirion's growing detector division can offer substantial volume cost reductions for large orders.

Test Circuits

Use HV+, R_a and R1 from the chart.

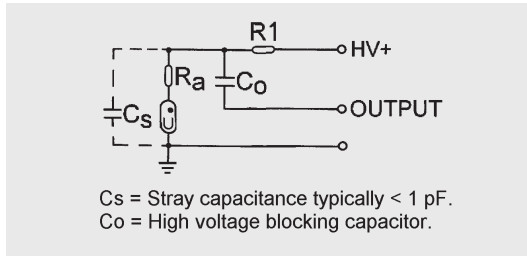

Figure 1- Anode Output

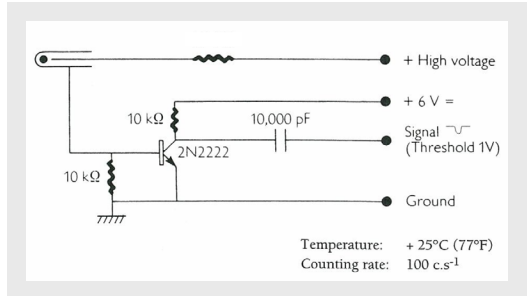
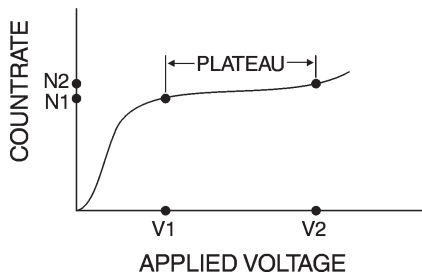

Figure 2- Cathode Output

Plateau Calculations

Plateau slope for this data sheet is calculated using the formula below, and given in units of percent change per 100 volts.



$$\frac{N2-N1}{1/2(N1+N2)} \times \frac{100}{V2-V1} \times 100 = \% \text{ per 100 volts}$$

Alpha Particle Detection

The table below shows the initial energy required to penetrate a given mica window thickness. This assumes a negligible air gap between the source and the window. Note the range of alpha particles of various energies in air at atmospheric pressure.

Mica Window	α Energy	α Range in Air
1.0 mg/cm ²	1.9 MeV	10 mm
2.0 mg/cm ²	2.6 MeV	15 mm
3.0 mg/cm ²	3.6 MeV	22 mm
4.0 mg/cm ²	4.5 MeV	29 mm

Beta Particle Detection

The chart below shows the effects of mica window thickness (mg/cm²) on beta particle absorption percentage.

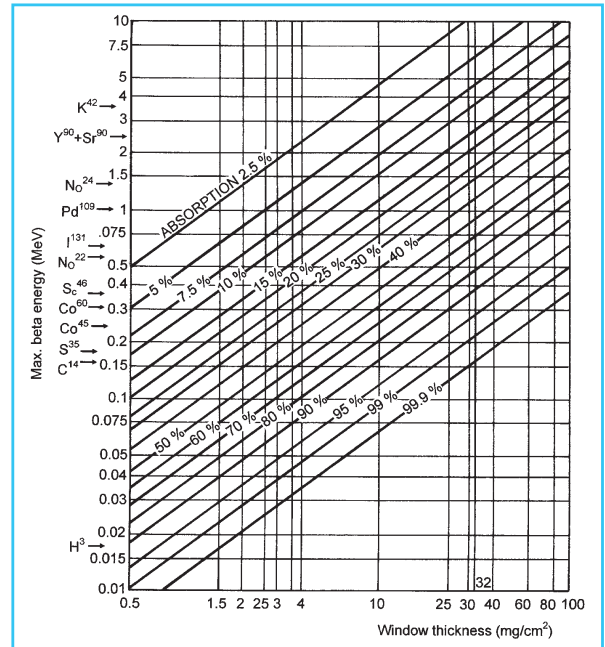

Dead Time Correction

GM detectors using conventional counting circuitry all exhibit counting losses due to the Dead Time factor. These factors cited in the Mirion detector data tables are based on the recommended operating voltages and test circuits. The chart below enables the user to estimate the counting losses due to the Dead Time factor at high count rates.

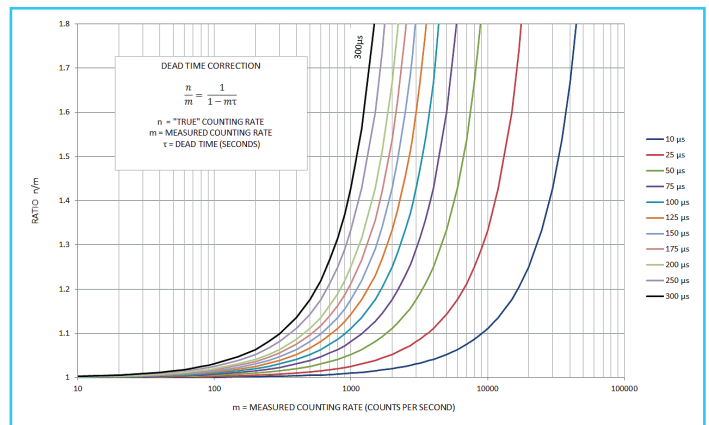

PERFORMANCE DATA

Pancake Detectors – For α, β, γ Applications						
Characteristics ↓	Detector Type →	T2000/8767	T2000/500*	T2006/900	T2006/500*	T2007/500*
Application		α, β, γ	α, β, γ	α, β, γ	α, β, γ	α, β, γ
Sensitivity*** ¹³⁷ CS cpm at 1 mR/h		3500	3500	3500	3500	3500
Window Area Density (mg/cm ²)		1.8 – 2.0	1.8 – 2.0	2.0 – 2.2	2.0 – 2.2	2.0 – 2.2
Window Effective Diameter (mm, in.)		44.5, 1.75	44.5, 1.75	44.5, 1.75	44.5, 1.75	44.5, 1.75
Recommended Operating Voltage		900	500	900	500	500
Plateau Length Volts min.		850-1000	450-600	850-1000	450-600	450-600
Plateau Slope (%/100 V max.)		10	10	10	10	10
Dead Time (μs max.)		50	50	50	50	50
Background (c/m)*** Shielding 2" Pb + 1/8" Al		30 max.	30 max.	30 max.	30 max.	30 max.
Test Circuit		Figure 1	Figure 1	Figure 1	Figure 1	Figure 1
Resistor, Ra (MΩ)		3.3	3.3	3.3	3.3	3.3
Resistor, R1 (MΩ)		1.0	1.0	1.0	1.0	1.0
Operating Temp (°C)		-20 to +55	-20 to +55	-20 to +55	-20 to +55	-20 to +55
Cathode Material		Cr/Fe	Cr/Fe	Cr/Fe	Cr/Fe	Cr/Fe
Window Recess (mm, in.)		1.6, 0.062	1.6, 0.062	1.6, 0.062	1.6, 0.062	1.6, 0.062

Pancake Detectors:

T2000/8767 & T2000/500*

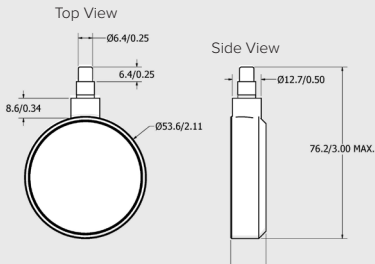

T2007/500*

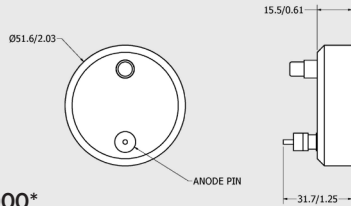

T2006/900 & T2006/500*

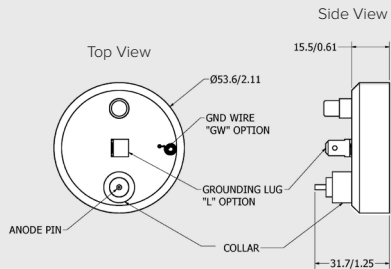

- * Alternate grounding options available.
- ** Energy compensated versions available.
- *** At recommended operating voltage.

Mica End Window – For α, β, γ Applications

Characteristics ↓	Detector Type →	T2121**
Application		α, β, γ
Sensitivity*** ¹³⁷ CS cpm at 1 mR/h		1700
Window Area Density (mg/cm ²)		1.8 – 2.0
Window Effective Diameter (mm, in.)		19.8, 0.78
Recommended Operating Voltage		500
Plateau Length Volts min.		450-650
Plateau Slope (%/100 V max.)		5
Dead Time (μs max.)		100
Background (c/m)*** Shielding 2" Pb + 1/8" Al		30 max.
Test Circuit		Figure 1
Resistor, Ra (MΩ)		3.3
Resistor, R1 (MΩ)		1.0
Operating Temp (°C)		-40 to +75
Cathode Material		Cr/Fe
Cathode Wall		1.3, 0.050
Window Recess (mm, in.)		1.6, 0.062

Mica End Window:

Mil. Version
2121 M Window
2.8–3.4 mg/cm²

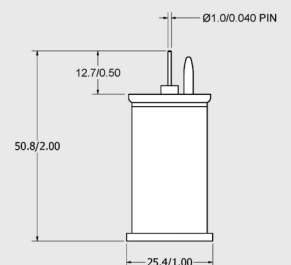

Gamma Sensitive Miniature Detectors – For γ Applications			
Characteristics ↓	Detector Type →	T2420**	T3G6500-1
Application		γ	γ
Sensitivity*** ¹³⁷ CS cpm at 1 mR/h		4.2	270
Recommended Operating Voltage		500	460
Plateau Length Volts min.		450-550	420-520
Plateau Slope (%/100 V max.)		35	30
Dead Time (μ s max.)		20	60
Background (c/m)*** Shielding 2" Pb + 1/8" Al		6 max.	25 max.
Test Circuit		Figure 2	Figure 2
Resistor, Ra (M Ω)		4.7	4.7
Resistor, R1 (M Ω)		N/A	N/A
Operating Temp (°C)		-51 to +71	-20 to +60
Cathode Material		Cr/Fe	Cr/Fe
Cathode Wall		360-400 mg/cm ²	280 mg/cm ²

Gamma Sensitive Miniature Detectors:

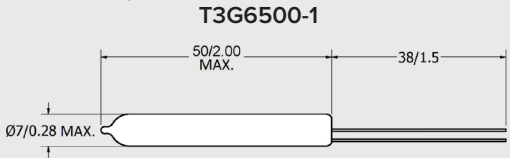
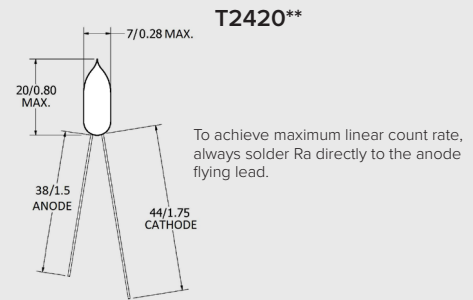

** Energy compensated versions available.
 *** At recommended operating voltage.

ORDERING INFORMATION

Pancake Detectors

Part Number	Notes
T2000/8767	—
T2000/500	—
T2000/500GW	T2000/500 with Ground Wire
T2006/500	—
T2006/500-NC	T2006/500 without Anode Support Collar
T2006/500GW	T2006/500 with Ground Wire
T2006/500GW-NC	T2006/500GW without Anode Support Collar
T2006/500L	T2006/500 with Ground Lug
T2006/500L-NC	T2006/500L without Anode Support Collar
T2006/900	—
T2007/500	—
7084948	T2007/500 with Ground Wire with Solder Lug

End Window Detectors

Part Number	Notes
T2121	—
T2121M	Military Version, Mica Thickness: 2.8-3.4 mg/cm ²
D102130	Energy Compensated T2121M, for RDS-110
9303666A	Energy Compensated T2121M, for ADM300
9335514A	Energy Compensated T2121M, for ADM300SI
T2121MG	T2121 with 0.0125" Metal Window

For additional information: www.mirion.com

Miniature Detectors

Part Number	Notes
T2420	—
9302553A	Energy Compensated T2420, for ADM300
7085395	Energy Compensated T2420, for NASRAMS
7086975	Energy Compensated T2420, for Seawater Probe
D3085197-GRN	Energy Compensated T2420 in Green Housing
D3085197-YEL	Energy Compensated T2420 in Yellow Housing
D703386-01	Energy Compensated T2420 in Gray Housing
T3G6500-1	—

